

# Hitachi Electromagnetic Contactors & Switches (up to 660 VAC)







# ELECTROMAGNETIC CONTACTORS AND SWITCHES

## CONTENTS

ELECTROMAGNETIC CONTACTORS AND SWITCHES	4
1. TYPES AND MODEL ARRANGEMENTS OF ELECTROMAGNETIC CONTACTORS AND SWITCHES	4
2. FEATURES OF NEW ELECTROMAGNETIC CONTACTORS AND SWITCHES (HS series).	5
3. FEATURES OF STANDARD TYPE ELECTROMAGNETIC CONTACTORS AND SWITCHES (H series).	7
4. RATINGS AND SPECIFICATIONS	10
4-1 ... Standard Models	12
4-2 ... Thermal Overload Relays	14
4-3 ... Electromagnetic Switches with 2E Thermal Overload Relay	16
4-4 ... DC Operated Electromagnetic Contactors	13
4-5 ... Latched Electromagnetic Contactors	18
4-6 ... Contact or Relays	20
5. STANDARD TYPE ELECTROMAGNETIC CONTACTORS AND SWITCHES	21
5-1 ... Coil Specifications.	21
5-2 ... Performance	21
5-3 ... Application for the International Standards	21
5-4 ... Normal Service Conditions	21
5-5 ... Selection	23
5-6 ... Cautions	27
5-7 ... Appearance and Dimensions	28
6. THERMAL OVERLOAD RELAYS	37
6-1 ... Construction	37
6-2 ... Tripping Characteristics	38
6-3 ... Application	39
6-4 ... Appearance and Dimensions	41
7. ELECTROMAGNETIC SWITCHES WITH 2E THERMAL OVERLOAD RELAY (OVERLOAD AND PHASE-FAILURE PROTECTION).	43
7-1 ... Phase-Failure Protection Effect of 2E Thermal Overload Relays	43
7-2 ... Appearance and Dimensions	43
8. DC OPERATED ELECTROMAGNETIC CONTACTORS	44
8-1 ... Operating Principle of Double Coil	44
8-2 ... Dimensions	44
9. LATCHED ELECTROMAGNETIC CONTACTORS.	45
9-1 ... Explanation of Operation	45
9-2 ... Dimensions	45
10. AUTOMATIC STAR-DELTA STARTERS (3-CONTACTORS TYPE)	47
10-1 . Ratings and Specifications	47
10-2 . Connection Diagram	48
10-3 . Dimensions	48
11. CONTACTOR RELAYS	49
11-1 . Application for the International Standards	49
11-2 . Return Spring Classification According to Contact Arrangement.	49
11-3 . Coil Ratings	43
11-4 . Contact Arrangement Diagram	50
11-5 . Dimensions and Mass.	50
12. OPTIONS	51
12-1 . Aux. Contact Block, Lamp Unit, Safety Cover and Mechanical Interlock Unit	51
12-2 . Coil Surge Absorber	52
13. OLD PRODUCTS (BACKLOG)	53
14. MAINTENANCE	56
K-TYPE MANUAL SWITCHES	58
PUSH BUTTONS (FOR OPERATING OF MAGNETIC CONTACTORS AND SWITCHES)	59

# ELECTROMAGNETIC CONTACTORS AND SWITCHES

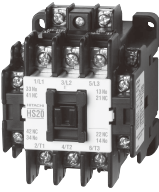
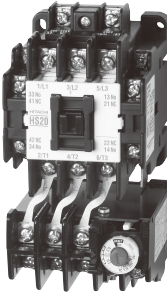
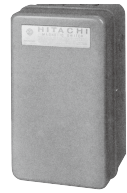
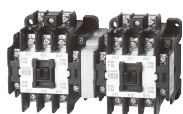
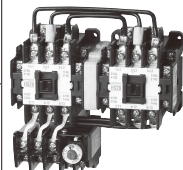
## 1. TYPES AND MODEL ARRANGEMENTS OF ELECTROMAGNETIC CONTACTORS AND SWITCHES

	Electromagnetic Contactors		Electromagnetic Switches			
			Without Enclosure		With Enclosure	
Non-reversible Type		<b>HS</b> □ 8-50 frame		<b>HS</b> □-T 8-50 frame		<b>SHS</b> □-T 10-50 frame
		<b>H</b> □ 65C-800C frame		<b>H</b> □-T 65C-600C frameΔ		<b>SH</b> □-T 65C-600C frame
Reversible Type 20-800C frame (:provided mechanical interlock)		<b>HS</b> □-R 10-50 frame		<b>HS</b> □-RT 10-50 frame		<b>SHS</b> □-RT 10-50 frame
		<b>H</b> □-R 65C-800C frame		<b>H</b> □-RT 65C-600C frame		<b>SH</b> □-RT 65C-600C frame

### Contactor Relays

**XS4**



**X** □

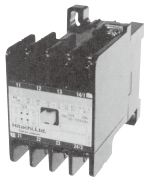

3-8 contacts (5 types)

### Thermal Overload Relays

**TR** □-□

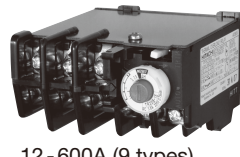

12-600A (9 types)

( Electromagnetic Switches with Thermal Overload Relay )

**H** □-T  
**H** □-TK

with 2E Thermal Overload Relay

### DC Operated Electromagnetic Contactors

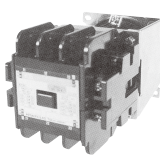

**H** □-G

10-800C frame

### Latched Electromagnetic Contactors

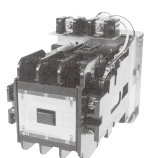

**H** □-L

10-600C frame

### Heavy Load Electromagnetic Contactors

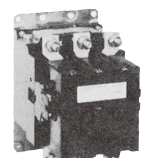

**H** □-H

10-200N frame



# HS series – New ELECTROMAGNETIC CONTACTORS AND SWITCHES

## 2. FEATURES OF NEW ELECTROMAGNETIC CONTACTORS AND SWITCHES (HS series)

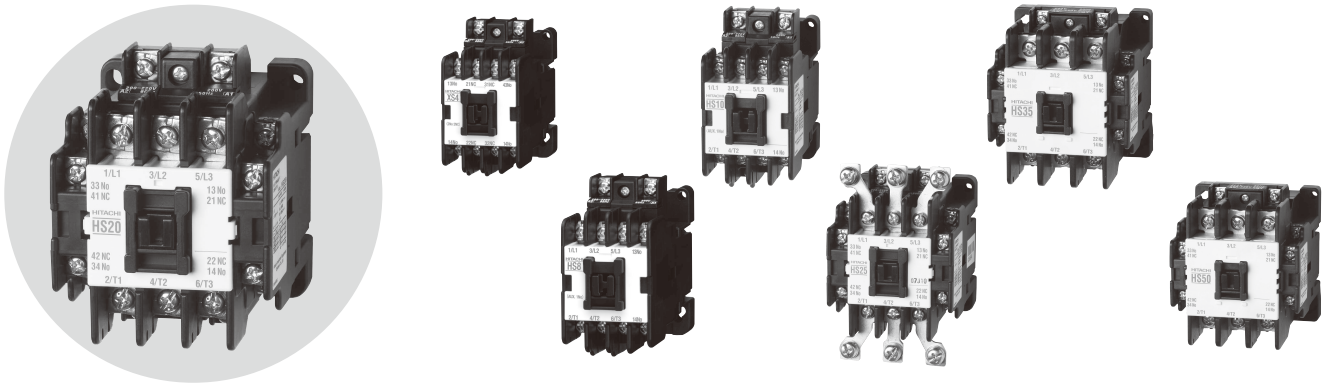

### ELECTROMAGNET RESISTANT TO VOLTAGE FLUCTUATIONS

The contactor maintains stable conducting performance even when the power supply voltage drops when started under load.

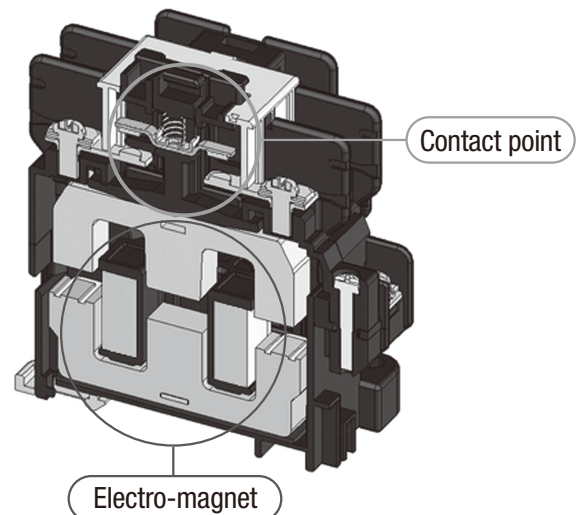
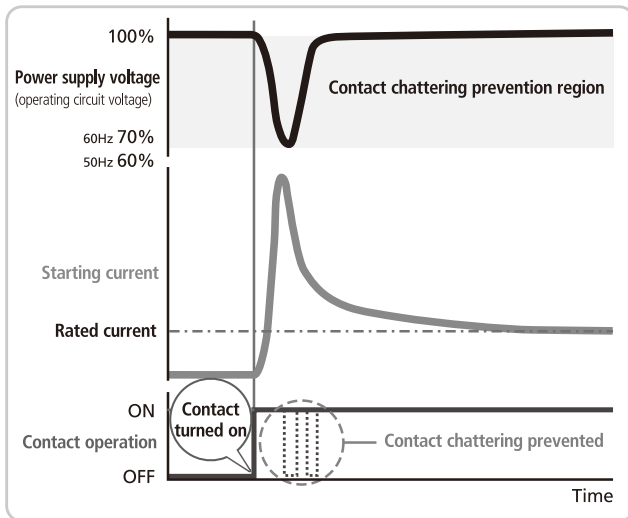

#### New shock-absorbing structure

Immediately before collision, the movable core and the fixed core move in the same direction to absorb the shock.

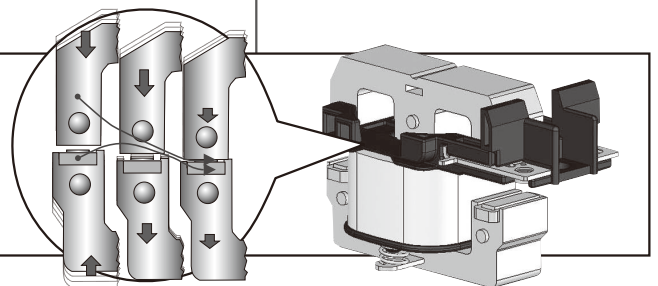

Stable operation

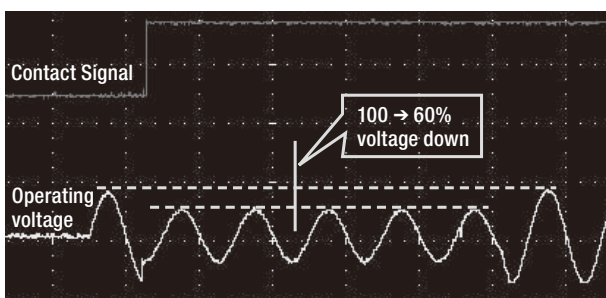

During contact chattering

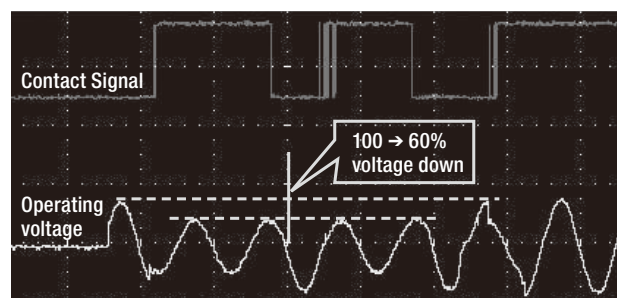

## IMPROVED ENVIRONMENTAL PERFORMANCE

### Reduced power consumption

The HS series reduces power consumption by operating coils with 20A to 50A frames.

Frame	20A	25A	35A	50A
Power consumption	86%	86%	82%	82%

(compared with conventional Hitachi IES products)

### Amount of materials used reduced, recyclable materials increased

The HS series improves environmental performance through miniaturization to reduce product weight and with indications of material names for easier recycling.



Example of indication for resin used

## IMPROVED USABILITY by Miniaturization and an Enhanced Auxiliary Contact Unit

### 15% height reduction

Improved magnet and contact efficiency greatly decreases the height from the mounting surface for 20A to 50A frames.

### Improved inching performance

The capability of the 10A frame has been upgraded to 2.2 kW and that of the 20A frame to 3.7 kW.

220VAC, 50% inching rate 50%, 100,000-operation service life (AC-4)

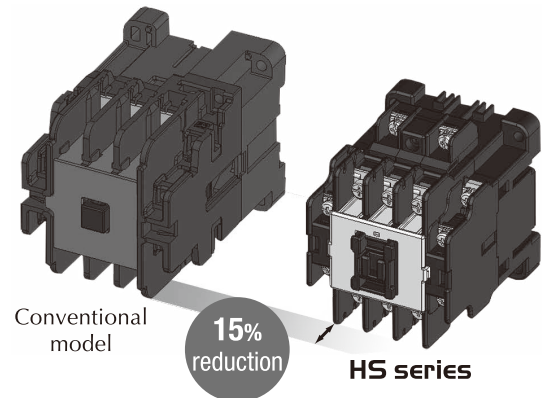
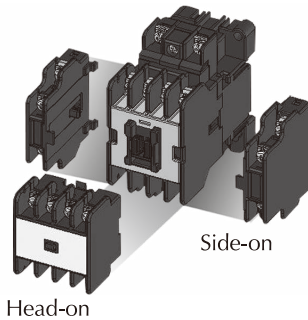

### Enhanced auxiliary contact unit

The capability of the 10A frame has been upgraded to 2.2kW and that of the 20A frame to 3.7 kW.

220VAC, 50% inching rate 50%, 100,000-operation service life (AC-4)

## IMPROVED RELIABILITY AND SAFETY

### Minimum load to 20V/5 mA on the auxiliary contact

The HS series uses a highly reliable twin contact to open or close the contact of a micro load circuit.

### Mechanical durability of 10 million operations

The HS series uses a new shock absorbing structure to improve durability.

### Safe contact opening

(the auxiliary b-contact is turned off during welding of the main contact)

The HS series complies with the requirements for control functions for failures specified in EN60204 for electrical equipment of industrial machinery.

### Fireproof materials used

Resin-molded parts use UL-approved fireproof materials to help improve system reliability.

### Protective cover (option)

You can opt for a protective cover applicable to the IP20.

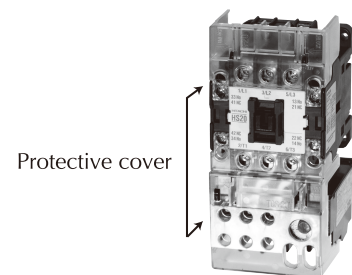

## COMPLIES WITH VARIOUS INTERNATIONAL STANDARDS

The HS series either complies with or expects to comply with various domestic and international standards.

JIS	IEC	VDE	EN	CE	TÜV	UL-CSA	CCC
Compliant					Awaiting certification		

# H series – STANDARD TYPE ELECTROMAGNETIC CONTACTORS AND SWITCHES

## 3. FEATURES OF STANDARD TYPE ELECTROMAGNETIC CONTACTORS AND SWITCHES (H series)

### NEW C-SERIES LINE-UP (65A TO 800A FRAME)

- **International standards approval.**

Conforms to IEC 60947-4-1, BS, DIN and VDE standards (H65C to H800C). Adapt to CE-Marking (H65C to H125C).

- **Applicable to use for crane and hoist due to shortened breaking time of contactors.**

### EASILY CERTAIN THE OPERATION BY COLOR INDICATOR

New color-indicators enable certain discrimination of moving.

#### Contactors

Color of indicator changes from green to red after the contactor is closed (H65C-H800C).

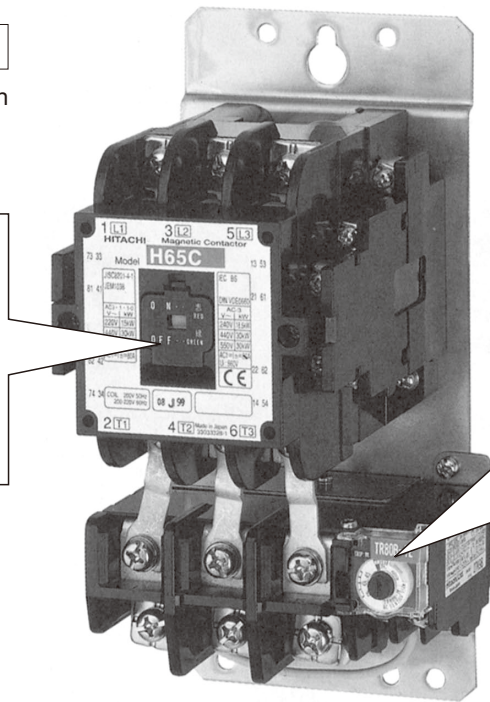
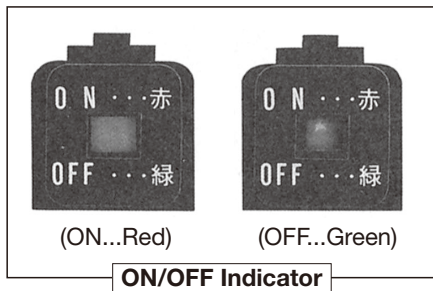

#### Thermal overload relays

Color of indicator changes from black to yellow if the thermal overload relay was tripped (All models).

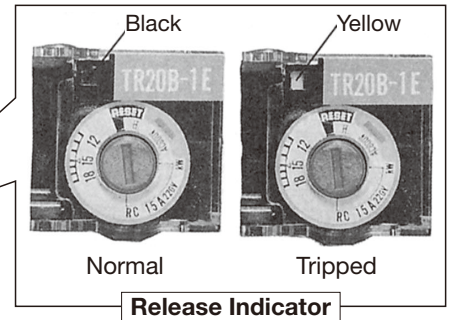

### NOISELESS ELECTRO-MAGNET COIL

Electromats excited on DC will not permit buzzing (H150C to H800C).

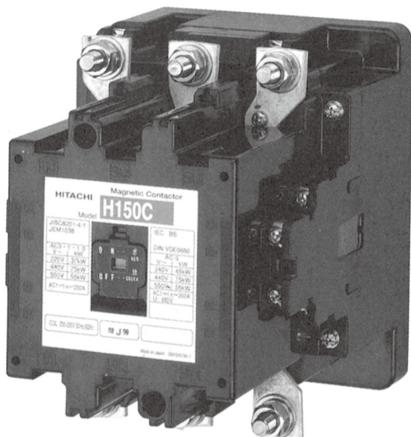

#### Stop buzzing

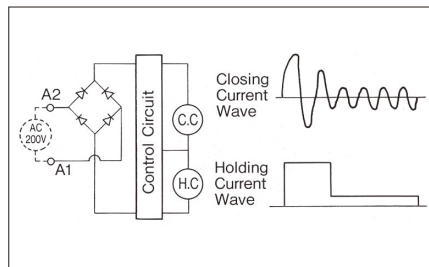

#### Built-in coil surge absorber

Built-in coil surge absorber prevents generation of surge voltage.

#### Voltage drop

Even if the operating voltage suddenly drops 65% of the rated voltage of contactors, contactors certainly keep on position without chattering.



## HIGH SAFETY

New preventive mechanism for mal-operation, phase separator, etc.

### ■ Preventive mechanism of careless operation

Contactors

· Sequence check rod will be operated when the indicator is opened (H65C-H800C).

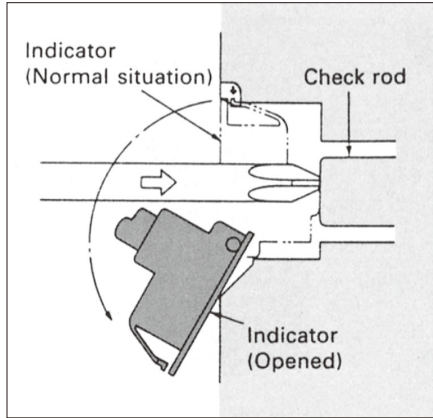

· Thermal overload relays “Cover” prevents the touch to release test lever (All models).

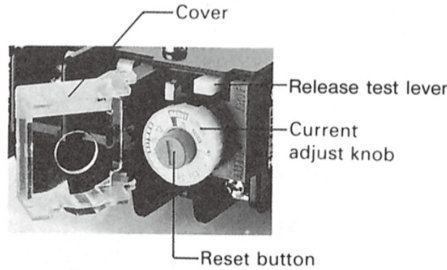

### ■ Free arc space

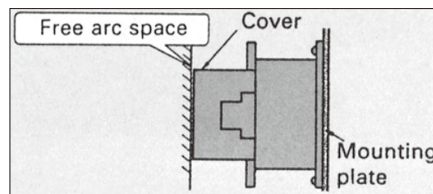

### ■ Phase separator

Additional phase separator (H80C-H800C).

Phase separators will be attached to the contactor.

### ■ Mechanical interlock

(Reversible type: over H20)

Mechanical interlock is also attached to reversible contactor.

### ■ Safety cover (option)

Easy attachment (H8C-H800C).

Live parts will be covered by safety cover, and it improves safety.

## HIGH RELIABILITY

Highly reliable contacts enable direct connection to the electronic circuits.

### ■ Auxiliary contacts of contactors

Rolling twin contacts assure high contact reliability (All models).

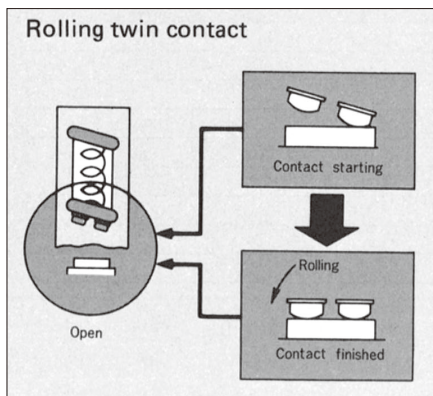

### ■ Signal contacts of thermal overload relays

Signal contacts of thermal overload relays are 1NO 1NC (All models).

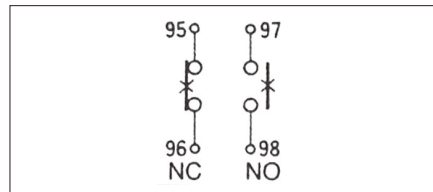

### ■ Auxiliary contact block (H20-H400C)

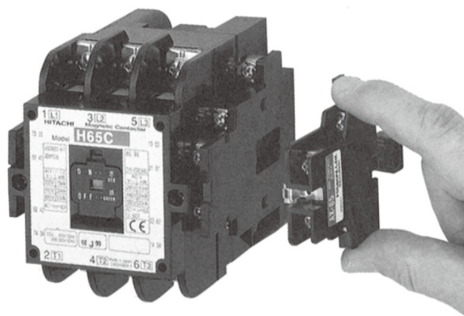

### ■ Coil surge absorber

Coil surge absorber will be installed by “Single Snap Action” (H8C-H125C), and H150C and above, it is constructed in coil assembly.

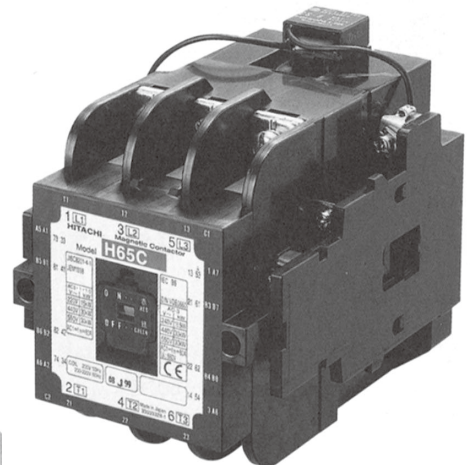



## EASY MAINTENANCE AND INSPECTION

### ■ Quick contact inspection

Access to contacts is done by unfastening two screws and removing the cover.

### ■ Easy contact replacement

Contact can be removed/replaced by single snap action without taking off the contact spring (H80C - H400C).

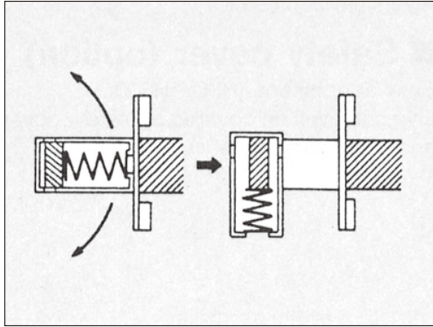

### ■ Easy wiring

- Adoption of washer-based self-up screw.
- Main terminal screw: up to H65C.
- Operation terminal screw: all models.
- Flat terminals built-in rugged studs facilitate connection of wires with a single spanner (H100C - H600C).

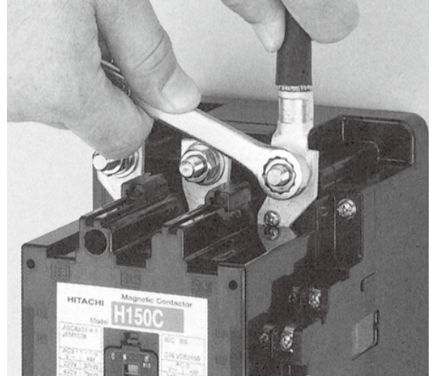

### ■ DIN rail mounting mechanism

H8C-H50 are available DIN rail mounting.

### ■ Front indication of nameplate

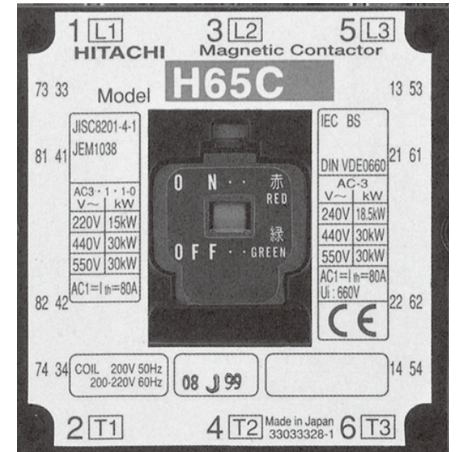

## THERMAL OVERLOAD RELAYS

Plentiful products enable easy selection of motor protection.

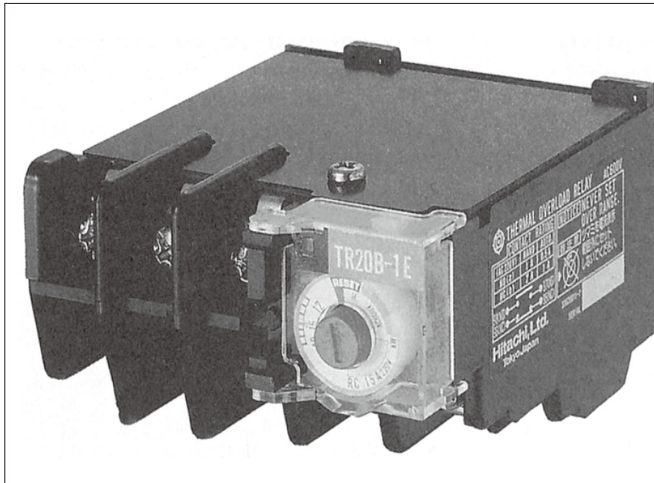

FRAME \ CATEGORY	Standard relay with overload protection (1E)	Relay with overload and single phasing protection (2E)
12B	applicable	applicable
20B	applicable	applicable
25B	applicable	applicable
50B	applicable	applicable
80B	applicable	applicable
150B	applicable	applicable
250B	applicable	applicable
400B	applicable	applicable
600B	applicable	applicable

### ■ Optional accessories

- Reset release...12B, 20B - 600B
- Trip indicating lamp...12B - 600B
- Safety cover...20B, 50B, 80B (except with CT)

### ■ Numbers of heat elements

- 1E...normally 2 Heat Elements. 3 Heat Elements type is also available as option.
- 2E...3 Heat Elements.

## IEC STANDARD

Contactors and thermal overload relays conform to the IEC standard.

## 4. RATINGS AND SPECIFICATIONS

### 4.1 Standard Models

With enclosure

<Electromagnetic contactor>   <Electromagnetic switch>   <Electromagnetic switch>  
 Non-reversible   ...   **HS**     **HS**   **-T**   **SHS**   **-T**  
 Reversible   ...   **HS**   **-R**   **HS**   **-RT**   **SHS**   **-RT**

Item				Frame		8	10	20	25	35	50																																	
Model	Electromagnetic contactor	without enclosure	Non-reversible	HS8	HS10	HS20	HS25	HS35	HS50																																			
			Reversible	—	HS10-R	HS20-R	HS25-R	HS35-R	HS50-R																																			
	Electromagnetic switch with 1E Thermal Overload Relay	without enclosure	Non-reversible	HS8-T	HS10-T	HS20-T	HS25-T	HS35-T	HS50-T																																			
			Reversible	—	HS10-RT	HS20-RT	HS25-RT	HS35-RT	HS50-RT																																			
		with enclosure	Non-reversible	—	SHS10-T	SHS20-T	SHS25-T	SHS35-T	SHS50-T																																			
			Reversible	—	SHS10-RT	SHS20-RT	SHS25-RT	SHS35-RT	SHS50-RT																																			
	Thermal overload relay			TR12B-1E		TR20B-1E	TR25B-1E	TR50B-1E																																				
	Rated insulation voltage (Ui)				690VAC																																							
Max. rated capacity of motor	Rated operational current (AC3)		200–220VAC	11A	13A	20 (18) A	26A	35A	50 (48) A																																			
			380–440VAC	7A	9A	17A	25A	32A	47A																																			
			500–550VAC	6A	9A	17A	20A	26A	37A																																			
	Single-phase motor (AC3) JIS, JEM and IEC		100–110VAC	0.4kW	0.5kW	0.9kW	1.2kW	1.7kW	—																																			
			200–220VAC	0.8kW	1kW	1.8kW	—	—	—																																			
	Three-phase motor (AC3)		200–220VAC	2.2kW	2.7kW	4 (3.7) kW	5.5kW	7.5kW	11kW																																			
			380–440VAC	2.7kW	4kW	7.5kW	11kW	15kW	22kW																																			
			500–550VAC	2.7kW	5.5kW	7.5kW	11kW	15kW	22kW																																			
	Three-phase motor (AC2)		200–220VAC	—	—	—	—	—	—																																			
			380–440VAC	—	—	—	—	—	—																																			
500–550VAC			—	—	—	—	—	—																																				
Inching (AC4) (Inching ratio 50%, electrical durability 0.1 million times) JIS, JEM and IEC		200–220VAC	1.5kW	2.2kW	3.7kW	3.7kW	5.5kW	7.5kW																																				
		380–440VAC	2.2kW	3.7kW	5.5kW	5.5kW	7.5kW	11kW																																				
Rated capacity for resistance load (AC1) (Electrical durability 0.5 million times) JIS, JEM and IEC		200–220VAC	20A	20A	32A	35A	50A	70A																																				
		380–440VAC	20A	20A	32A	35A	50A	70A																																				
Rated thermal current (Ith)		without enclosure	20A	20A	32A	35A	50A	70A																																				
Open thermoelectric current (Ith)		with enclosure	15A	15A	26A	35A	44A	60A																																				
Characteristics of operation coil	Coil burden (max.) 50/60Hz		At power-on	100/90VA	100/90VA	100/90VA	100/90VA	135/125VA	135/125VA																																			
			After power-on	12/11VA	12/11VA	12/11VA	12/11VA	15/14VA	15/14VA																																			
	Coil consumption (mean)			3W				4.3W																																				
	Pick-up voltage (% of rated voltage) (mean)			70%	70%	70%	70%	70%	70%																																			
	Drop-out voltage (% of rated voltage) (mean)			55%	55%	60%	60%	60%	60%																																			
Operating time (reference value)		At power-on	10–20ms																																									
		At release	10–35ms																																									
Type of constant			Twin contact																																									
Numbers		Standard	1N0 or 1NC			1N01NC or 2N02NC			2N02NC																																			
		Maximum	Four contacts can be added to the standard specification. Head-on2P: 2N0, 1N01NC, 2NC (サイドオンと同一本体に取り付けての使用不可) Head-on4P: 4N0, 3N01NC, 2N02NC (サイドオンと同一本体に取り付けての使用不可) Side-on2P: 1N01NC (ヘッドオンと同一本体に取付けての使用不可)																																									
Rated thermal current		<table border="1" style="width: 100%; text-align: center;"> <thead> <tr> <th colspan="2">AC-12</th> <th colspan="3">AC-15</th> <th colspan="2">DC-12</th> <th colspan="3">DC-13</th> <th rowspan="2">Minimum rating</th> </tr> <tr> <th>110V</th> <th>220V</th> <th>110V</th> <th>220V</th> <th>440V</th> <th>110V</th> <th>220V</th> <th>110V</th> <th>220V</th> <th>440V</th> </tr> </thead> <tbody> <tr> <td>10A</td> <td>8A</td> <td>6A</td> <td>3A</td> <td>1.5A</td> <td>2.5A</td> <td>1A</td> <td>1.5A</td> <td>0.55A</td> <td>0.27A</td> <td>20V 5mA</td> </tr> </tbody> </table>											AC-12		AC-15			DC-12		DC-13			Minimum rating	110V	220V	110V	220V	440V	110V	220V	110V	220V	440V	10A	8A	6A	3A	1.5A	2.5A	1A	1.5A	0.55A	0.27A	20V 5mA
		AC-12		AC-15			DC-12		DC-13			Minimum rating																																
110V	220V	110V	220V	440V	110V	220V	110V	220V	440V																																			
10A	8A	6A	3A	1.5A	2.5A	1A	1.5A	0.55A	0.27A	20V 5mA																																		
With mechanical interlock			—									Provided as standard																																
IEC 35-mm rail mounting mechanism			—									Provided as standard																																
Durability		Mechanical	8 million times																																									
		Electrical	2 million times			1.5 million times			1 million times																																			
Available voltage range of operational coil			24–550V																																									

#### Notes:

- The ratings of the 200V class in the parenthesis when frames 20 and 50 are provided with an enclosure.
- The rated thermal current applies to electromagnetic contactors.
- The pick-up and drop-out voltages apply to 200V 60Hz power source. In case of 50Hz, the figures for frame 8C–125C are about 10% smaller and for frame 150C–800C are about the same.
- Application of Category AC3 and AC2 to the reversible electromagnetic contactors and switches shall be limited to regular reversible operation in which a motor starts reverse rotation after it has once stopped. Category AC4 is applicable when the motor starts reverse rotation before it has completely stopped.
- The mark (standard) in the application indicates that they are standard.
- Operating time is a reference value where 200V 50Hz is applied to AC 200V coil. Operating time varies with coil voltage, frequency and phase so it is unsuitable for timing use.

With enclosure

<Electromagnetic contactor>   <Electromagnetic switch>   <Electromagnetic switch>  
 Non-reversible   ...   **HS**    **HS**  -T   **SHS**  -T  
 Reversible   ...   **HS**  -R   **HS**  -RT   **SHS**  -RT

	65C	80C	100C	125C	150C	200C	250C	300C	400C	600C	800C																
	H65C	H80C	H100C	H125C	H150C	H200C	H250C	H300C	H400C	H600C	H800C																
	H65C-R	H80C-R	H100C-R	H125C-R	H150C-R	H200C-R	H250C-R	H300C-R	H400C-R	H600C-R	H800C-R																
	H65C-T	H80C-T	H100C-T	H125C-T	H150C-T	H200C-T	H250C-T	H300C-T	H400C-T	H600C-T	—																
	H65C-RT	H80C-RT	H100C-RT	H125C-RT	H150C-RT	H200C-RT	H250C-RT	H300C-RT	H400C-RT	H600C-RT	—																
	SH65C-T	SH80C-T	SH100C-T	SH125C-T	SH150C-T	SH200C-T	SH250C-T	SH300C-T	SH400C-T	SH600C-T	—																
	SH65C-RT	SH80C-RT	SH100C-RT	SH125C-RT	SH150C-RT	SH200C-RT	SH250C-RT	SH300C-RT	SH400C-RT	SH600C-RT	—																
	TR80B-1E		TR150B-1E			TR250B-1E*		TR400B-1E*		TR600B-1E*	—																
	660VAC																										
	65A	80A	100A	125A	150A	180A	240A	300A	400A	600A	800A (AC2)																
	65A	80A	100A	125A	150A	180A	240A	300A	400A	600A	800A (AC2)																
	52A	72A	72A	72A	80A	145A	145A	250A	350A	500A	—																
	—	—	—	—	—	—	—	—	—	—	—																
	—	—	—	—	—	—	—	—	—	—	—																
	15kW	19kW	25kW	30kW	37kW	45kW	60kW	75kW	110kW	150kW	—																
	30kW	37kW	50kW	60kW	75kW	90kW	120kW	150kW	200kW	300kW	—																
	30kW	45kW	45kW	45kW	55kW	90kW	90kW	160kW	200kW	300kW	—																
	15kW	19kW	25kW	30kW	37kW	45kW	60kW	75kW	110kW	150kW	200kW																
	30kW	37kW	50kW	60kW	75kW	90kW	120kW	150kW	200kW	300kW	400kW																
	30kW	45kW	45kW	45kW	55kW	90kW	90kW	160kW	200kW	300kW	—																
	9kW	13kW	13kW	13kW	22kW	30kW	37kW	45kW	45kW	55kW	—																
	15kW	19kW	19kW	19kW	30kW	37kW	45kW	55kW	55kW	75kW	—																
	80A	120A	135A	150A	200A	260A	300A	350A	420A	600A	800A (0.1 million times)																
	80A	120A	135A	150A	200A	260A	300A	350A	420A	600A	800A (0.1 million times)																
	80A	120A	135A	150A	200A	260A	300A	350A	420A	600A	800A																
	65A	80A	100A	125A	150A	180A	240A	300A	400A	600A	—																
	220/190VA	490/420VA		400/400VA		480/480VA		1600/1600VA		1800/1800VA																	
	18/14VA	50/40VA		8/8VA		9/9VA		10/10VA		14/14VA																	
	6W	9.5W		7W		8W		8W		13W																	
	75%	75%		70%		70%		70%		70%																	
	58%	58%		45%		45%		35%		35%																	
	10–20ms	10–25ms		30–50ms		30–50ms		35–60ms		40–70ms																	
	10–30ms	10–30ms		20–40ms		20–45ms		20–45ms		20–50ms																	
	Twin contact																										
	2N02NC						3N03NC																				
	4N04NC (可逆形の場合 最大3N03NC)																										
	<table border="1" style="margin: auto; border-collapse: collapse; text-align: center;"> <tr> <th colspan="3">AC-15</th> <th colspan="2">DC L/R≤40ms</th> <th rowspan="3">Minimum rating</th> </tr> <tr> <td>200–220V</td> <td>380–440V</td> <td>500–550V</td> <td>48V</td> <td>110V</td> </tr> <tr> <td>2A</td> <td>1A</td> <td>0.75A</td> <td>0.7A</td> <td>0.3A</td> </tr> </table>					AC-15			DC L/R≤40ms		Minimum rating	200–220V	380–440V	500–550V	48V	110V	2A	1A	0.75A	0.7A	0.3A	24V 10mA					
AC-15			DC L/R≤40ms		Minimum rating																						
200–220V	380–440V	500–550V	48V	110V																							
2A	1A	0.75A	0.7A	0.3A																							
	Provided as standard																										
	—																										
	5 million times																										
	1 million times						0.5 million times																				
	24–550V				100–440V																						

- 7) Testing conditions of electrical durability (Category AC3):  
The making and breaking currents and operating frequency of the electrical durability are tested as shown in the right drawing according to test conditions of JIS C8201-4-1, JEM 1038 and IEC 60947-4-1.
- 8) \*Thermal overload relay for 220–240V 7.5kW is TR50B-1E.
- 9) The minimum rating of auxiliary contact is 48V 10mA for the single contact and 24V 10mA for the twin contact.

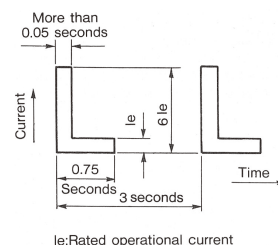

## 4.2 Thermal Overload Relays

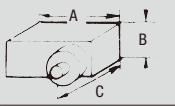
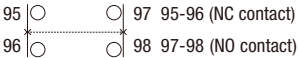
Type		Standard type (1E) thermal overload relays (Overload and lock protections)															
Frame		12B		20B		25B	50B	80B	150B	250B	400B	600B					
Model		TR12B-1E		TR20B-1E		TR25B-1E	TR50B-1E	TR80B-1E	TR150B-1E	TR250B-1E	TR400B-1E	TR600B-1E					
Heater specifications	Type of heater (Center RC value) (A)	0.2	0.3	0.2	0.3	20	9	20	80	(140)	(140)	(140)					
		0.5	0.8	0.5	0.8	22	11	28	105	(240)	(240)	(240)					
		1.2	1.4	1.2	1.4	25	15	40	130	TR20B-1E with CT (ratio 100:1) The figure in the parenthesis is the current of primary side.	(380)	(380)					
		2.4	3.8	2.4	3.8		20	55	(500)								
		5.0	6.8	5.0	6.8		28	67									
		9	11	9	11		40	55									
	*Numbers of Heat Elements		2		2		2	2	2	2	2	2					
Heat Element consumption VA (VA/1 phase)		1.9		1.9		1.9	4.1	7.6	7.6	1.9	1.9	1.9					
External dimensions (mm)		A	45	63	63	85	102.5	102.5	148	164	230						
		B	71	45	54	45	55	87	120	135	179						
		C (Height to reset button)	78.5	72.5	72.5	73.5	73.5	73.5	167	167	170						
Net mass (kg)		0.1		0.15		0.17	0.25	0.36	0.37	2.0	2.0	5.0					
Terminal screw diam.	Main circuit	M3.5		M4		M4 (Line) M5 (Load)	M5	M6	M6 (Line) M8 (Load)	M10	M12	M12					
	Operating circuit	M3.5		M3.5		M3.5	M3.5	M3.5	M3.5	M3.5	M3.5	M3.5					
Contact Specifications	Type of contact		1N01NC														
	Arrangement																
	Rated insulation voltage		AC660V														
	Rated thermal current (A)		NC contact : 3, NO contact : 2														
	Rated operational current (A) (Values in parenthesis for automatic reset)	AC (AC15)	110V	NC contact : 3 (1), NO contact : 2 (0.5)													
			220V	NC contact : 2 (1), NO contact : 1 (0.5)													
			440V	NC contact : 1 (0.3), NO contact : 0.5 (0.2)													
550V			NC contact : 1 (0.3), NO contact : 0.5 (0.2)														
DC L/R ≤ 40ms	24V	NC contact : 1 (0.4), NO contact : 0.5 (0.2)															
	48V	NC contact : 0.5 (0.2), NO contact : 0.2 (0.1)															
	110V	NC contact : 0.2 (0.1), NO contact : 0.1 (0.05)															
	220V	NC contact : 0.1 (0.05), NO contact : 0.1 (0.05)															
Minimum rating		***NC contact : 20V 5mA, NO contact : 20V 5mA															
Reset method		**both a Manual and Automatic reset															
Separate mounting		option	standard	option	standard	option	standard	option	standard	option	standard	refer Note 4)					
Option	Reset release	option															
	Lamp unit	—															
	Safety cover	—	option	—	option	—	—	—	—	—	—	—					
	Separate (DIN rail) mounting unit	option	—	—	—	—	—	—	—	—	—	—					
Applicable electromagnetic contactor	H8C	H20		H25		H35		H65C		H100C		H200C		H300C		H600C	
	H10C	HS20		HS25		H50		H80C		H125C		H250C		H400C			
	H11					HS35				H150C							
	H12					HS50											
	HS8, HS10																
Conforming standard		JIS C8201-4-1, JEM1038, IEC 60947-4-1, BS, VDE (3 Heat Elements only)															

### Notes:

- In case of mounting for Electromagnetic Contactor H25, HS25 and required 15A or less RC value, applied 20B frame with extension terminals.
- In case of mounting for Electromagnetic Contactor H100C-150C and required 67A or less RC value, applied 80B frame with extension terminals.
- If 25B or 150B frame is mounted separately, ordering form shall be "Type" + "RC value" + "Separate Mounting". And 25B or 150B frame with Extension Terminals for both Load and Line terminals is supplied.
- For separate mounting of 150B frame and above rating, TR400B-□ separate mounting type is supplied.
- \*3 Heat Elements type is available for standard type with 2 Heat Elements.
- Marked ☆ TR250B-TR600B-□ are Type names for TR20B-□ with CT (ratio 100:1)  
On the Relay mounted to Electromagnetic Contactor at factory, marked ☆ Type name is not indicated.
- \*\* Relay is set in manual reset when shipped from factory.
- \*\*\* 振動・衝撃が加わる設置条件では適用外となりますので、ご注意ください。



2E thermal overload relays (Overload, lock and phase-failure protections) ☆ ☆ ☆											
12B		20B		25B	50B	80B	150B	250B	400B	600B	
TR12B-2E		TR20B-2E		TR25B-2E	TR50B-2E	TR80B-2E	TR150B-2E	TR250B-2E	TR400B-2E	TR600B-2E	
0.2	0.3	0.2	0.3	20	9	20	80	(140)	(140)	(140)	
0.4	0.5	0.4	0.5	22	11	28	105	(180)	(180)	(180)	
0.6	0.8	0.6	0.8	25	15	40	130	(240)	(240)	(240)	
1.0	1.2	1.0	1.2		20	55	150	250	(300)	(300)	
1.4	1.8	1.4	1.8		28	67			(380)	(380)	
2.4	3.0	2.4	3.0		40	55			(500)		
3.8	5.0	3.8	5.0		55						
6.8	9.0	6.8	9.0								
11		11	15								
3		3		3	3	3			3	3	3
1.9		1.9		1.9	4.1	7.6	7.6	1.9	1.9	1.9	
45		63		63	85	102.5	102.5	148	164	230	
71		45		54	45	55	87	129	135	179	
78.5		72.5		72.5	73.5	73.5	73.5	167	167	170	
0.1		0.15		0.17	0.25	0.36	0.37	2.0	2.0	5.0	
M3.5		M4		M4 (Line) M5 (Load)	M5	M6	M6 (Line) M8 (Load)	M10	M12	M12	
M3.5		M3.5		M3.5	M3.5	M3.5	M3.5	M3.5	M3.5	M3.5	
1N01NC											
AC660V											
NC contact : 3, NO contact : 2											
NC contact : 3 (1), NO contact : 2 (0.5)											
NC contact : 2 (1), NO contact : 1 (0.5)											
NC contact : 1 (0.3), NO contact : 0.5 (0.2)											
NC contact : 1 (0.3), NO contact : 0.5 (0.2)											
NC contact : 1 (0.4), NO contact : 0.5 (0.2)											
NC contact : 0.5 (0.2), NO contact : 0.2 (0.1)											
NC contact : 0.2 (0.1), NO contact : 0.1 (0.05)											
NC contact : 0.1 (0.05), NO contact : 0.1 (0.05)											
***NC contact : 20V 5mA, NO contact : 20V 5mA											
**both a Manual and Automatic reset											
option	standard	option	standard	option	standard	option	standard	option	standard	refer Note 4.	
option											
—	option	—	option	—	option	—	option	—	option	—	
option	—	option	—	option	—	option	—	option	—	option	
H8C	H20	H25	H35	H65C	H100C	H200C	H300C	H600C			
H10C	HS20	HS25	H50	H80C	H125C	H250C	H400C				
H11			HS35		H150C						
H12			HS50								
HS8, HS10											
JIS, JEM, IEC, NEMA, VDE, BS					JIS, JEM, IEC, NEMA, VDE, BS						

## 4.3 Electromagnetic Switches with 2E Thermal Overload Relay

Item			Frame	8	10	20	25	35	50																																		
Electromagnetic switch with 2E thermal overload relay	without enclosure	Non-reversible	—	HS10-TK	HS20-TK	HS25-TK	HS35-TK	HS50-TK																																			
		Reversible	—	HS10-RTK	HS20-RTK	HS25-RTK	HS35-RTK	HS50-RTK																																			
	with enclosure	Non-reversible	—	SHS10-TK	SHS20-TK	SHS25-TK	SHS35-TK	SHS50-TK																																			
		Reversible	—	SHS10-RTK	SHS20-RTK	SHS25-RTK	SHS35-RTK	SHS50-RTK																																			
	Thermal overload relay			TR12B-2E	TR20B-2E	TR25B-2E	TR50B-2E																																				
Rated insulation voltage (Ui)			690VAC																																								
Max. rated capacity of motor	Rated operational current (AC3)	200–220VAC	11A	13A	20 (18) A	26A	35A	50 (48) A																																			
		380–440VAC	7A	9A	17A	25A	32A	47A																																			
		500–550VAC	6A	9A	17A	20A	26A	37A																																			
	Single-phase motor (AC3) JIS, JEM and IEC	100–110VAC	0.4kW	0.5kW	0.9kW	1.2kW	1.7kW	—																																			
		200–220VAC	0.8kW	1kW	1.8kW	—	—	—																																			
	Three-phase motor (AC3)	200–220VAC	2.2kW	2.7kW	4 (3.7) kW	5.5kW	7.5kW	11kW																																			
		380–440VAC	2.7kW	4kW	7.5kW	11kW	15kW	22kW																																			
		500–550VAC	2.7kW	5.5kW	7.5kW	11kW	15kW	22kW																																			
	Three-phase motor (AC2)	200–220VAC	—	—	—	—	—	—																																			
		380–440VAC	—	—	—	—	—	—																																			
		500–550VAC	—	—	—	—	—	—																																			
	Inching (AC4) (Inching ratio 50%, electrical durability 0.1 million times) JIS, JEM and IEC	200–220VAC	1.5kW	2.2kW	3.7kW	3.7kW	5.5kW	7.5kW																																			
380–440VAC		2.2kW	3.7kW	5.5kW	5.5kW	7.5kW	11kW																																				
Characteristics of operation coil	Coil burden (max.) 50/60Hz	At power-on	100/90VA	100/90VA	100/90VA	100/90VA	135/125VA	135/125VA																																			
		After power-on	12/11VA	12/11VA	12/11VA	12/11VA	15/14VA	15/14VA																																			
	Coil consumption (mean)		3W					4.3W																																			
	Pick-up voltage (% of rated voltage) (mean)		70%	70%	70%	70%	70%	70%																																			
	Drop-out voltage (% of rated voltage) (mean)		55%	55%	60%	60%	60%	60%																																			
	Operating time (reference value)	At power-on	10–20ms																																								
At release		10–35ms																																									
Auxiliary contact specification	Type of constant		Twin contact																																								
	Numbers	Standard	1NO or 1NC		1NO1NC or 2NO2NC		2NO2NC																																				
		Maximum	Four contacts can be added to the standard specification. Head-on2P: 2NO, 1NO1NC, 2NC ( サイドオンと同一本体に取り付けての使用不可 ) Head-on4P: 4NO, 3NO1NC, 2NO2NC ( サイドオンと同一本体に取り付けての使用不可 ) Side-on2P: 1NO1NC ( ヘッドオンと同一本体に取付ての使用不可 )																																								
Rated thermal current		<table border="1"> <thead> <tr> <th colspan="2">AC-12</th> <th colspan="3">AC-15</th> <th colspan="2">DC-12</th> <th colspan="3">DC-13</th> <th rowspan="2">Minimum rating</th> </tr> <tr> <th>110V</th> <th>220V</th> <th>110V</th> <th>220V</th> <th>440V</th> <th>110V</th> <th>220V</th> <th>110V</th> <th>220V</th> <th>440V</th> </tr> </thead> <tbody> <tr> <td>10A</td> <td>8A</td> <td>6A</td> <td>3A</td> <td>1.5A</td> <td>2.5A</td> <td>1A</td> <td>1.5A</td> <td>0.55A</td> <td>0.27A</td> <td>20V 5mA</td> </tr> </tbody> </table>										AC-12		AC-15			DC-12		DC-13			Minimum rating	110V	220V	110V	220V	440V	110V	220V	110V	220V	440V	10A	8A	6A	3A	1.5A	2.5A	1A	1.5A	0.55A	0.27A	20V 5mA
AC-12		AC-15			DC-12		DC-13			Minimum rating																																	
110V	220V	110V	220V	440V	110V	220V	110V	220V	440V																																		
10A	8A	6A	3A	1.5A	2.5A	1A	1.5A	0.55A	0.27A	20V 5mA																																	
With mechanical interlock			—	Provided as standard																																							
IEC 35-mm rail mounting mechanism			Provided as standard																																								
Durability	Mechanical		8 million times																																								
	Electrical		2 million times		1.5 million times		1 million times																																				
Available voltage range of operational coil			24–550V																																								

### Notes:

#### 1) Rating of Auxiliary Contact

Rated operational current					Rated thermal current	Minimum rating
AC (AC15)			DC L/R≤40ms			
200–220V	380–440V	500–550V	48V	110V		
2A	1A	0.75A	0.7A	0.3A	10A	24V 10mA

- The ratings of Max. rated capacity of motor in the parenthesis are provided with an enclosure.
- The pick-up and drop-out voltage apply to 200V, 60Hz power source. In case of 50Hz, the figures for frame 8C–125C are about 10% smaller and figures for frame 150C–600C are about the same.
- Application of Category AC3 and AC2 to the reversible electromagnetic switches shall be limited to regular reversible operation in which a motor starts reverse rotation after it has once stopped. Category AC4 is applicable when the motor starts reverse rotation before it has completely stopped. And the contactors used for reversible operation, they must be electrically interlocked using by mutual NC auxiliary contacts.
- Since operating time depends on coil voltage, frequency or phase etc., the switches must not be applied for timing use.
- \*Thermal overload relay for 220–240V 7.5kW is TR50B-2E.

With enclosure

<Electromagnetic contactor> <Electromagnetic switch>

Non-reversible ... **HS**  -TK    **SHS**  -TK    Non-reversible ... **H**  -TK    **SH**  -TK

Reversible ... **HS**  -RKT    **SHS**  -RTK    Reversible ... **H**  -RKT    **SH**  -RTK

With enclosure

<Electromagnetic contactor With 2E thermal overload relay> <Electromagnetic switch>

	65C	80C	100C	125C	150C	200C	250C	300C	400C	600C
	H65C-TK	H80C-TK	H100C-TK	H125C-TK	H150C-TK	H200C-TK	H250C-TK	H300C-TK	H400C-TK	H600C-TK
	H65C-RTK	H80C-RTK	H100C-RTK	H125C-RTK	H150C-RTK	H200C-RTK	H250C-RTK	H300C-RTK	H400C-RTK	H600C-RTK
	SH65C-TK	SH80C-TK	SH100C-TK	SH125C-TK	SH150C-TK	SH200C-TK	SH250C-TK	SH300C-TK	SH400C-TK	SH600C-TK
	SH65C-RTK	SH80C-RTK	SH100C-RTK	SH125C-RTK	SH150C-RTK	SH200C-RTK	SH250C-RTK	SH300C-RTK	SH400C-RTK	SH600C-RTK
	TR80B-2E		TR150B-2E			TR250B-2E*		TR400B-2E*		TR600B-2E*
	660VAC									
	65A	80A	100A	125A	150A	180A	240A	300A	400A	600A
	65A	80A	100A	125A	150A	180A	240A	300A	400A	600A
	52A	72A	72A	72A	80A	145A	145A	250A	350A	500A
	—	—	—	—	—	—	—	—	—	—
	—	—	—	—	—	—	—	—	—	—
	15kW	19kW	25kW	30kW	37kW	45kW	60kW	75kW	110kW	150kW
	30kW	37kW	50kW	60kW	75kW	90kW	120kW	150kW	200kW	300kW
	30kW	45kW	45kW	45kW	55kW	90kW	90kW	160kW	200kW	300kW
	15kW	19kW	25kW	30kW	37kW	45kW	60kW	75kW	110kW	150kW
	30kW	37kW	50kW	60kW	75kW	90kW	120kW	150kW	200kW	300kW
	30kW	45kW	45kW	45kW	55kW	90kW	90kW	160kW	200kW	300kW
	9kW	13kW	13kW	13kW	22kW	30kW	37kW	45kW	45kW	55kW
	15kW	19kW	19kW	19kW	30kW	37kW	45kW	55kW	55kW	75kW
	220/190VA	490/420VA			400/400VA	480/480VA		1600/1600VA		1800/1800VA
	18/14VA	50/40VA			8/8VA	9/9VA		10/10VA		14/14VA
	6W	9.5W			7W	8W		8W		13W
	75%	75%			70%	70%		70%		70%
	58%	58%			45%	45%		35%		35%
	10-20ms	10-25ms			30-50ms	30-50ms		35-60ms		40-70ms
	10-30ms	10-30ms			20-40ms	20-45ms		20-45ms		20-50ms
	Twin contact									
	2N02NC							3N03NC		
	4N04NC (可逆形の場合 最大3N03NC)									
	AC-15					DC L/R≤40ms			Minimum rating	
	200-220V	380-440V	500-550V	48V	110V					
	2A	1A	0.75A	0.7A	0.3A					
	24V 10mA									
	Provided as standard									
	—									
	5 million times									
	1 million times					0.5 million times				
	24-550V				100-440V					

## 4.4 DC Operated Electromagnetic Contactors

Item		Frame	10	11	20	25	35	50	65C
Model	Non-reversible		H10-G	H11-G	H20-G	H25-G	H35-G	H50-G	H65C-G
	Reversible		—	H11-RG	H20-RG	H25-RG	H35RG	H50-RG	H65C-RG
Rated insulation voltage (Ui)			660VAC						
Max. rated capacity of motor	Rated operational current (AC3)	200–220VAC	12A	12A	20A	26A	35A	50A	65A
		380–440VAC	9A	9A	17A	24A	32A	47A	65A
		500–550VAC	8A	8A	12A	12A	26A	37A	52A
	Single-phase motor (AC3) JIS, JEM and IEC	100–110VAC	0.4kW	0.4kW	0.75kW	—	—	—	—
		200–220VAC	0.75kW	0.75kW	—	—	—	—	—
	Three-phase motor (AC3)	200–220VAC	2.5kW	2.5kW	4kW	5.5kW	7.5kW	11kW	15kW
		380–440VAC	4kW	4kW	7.5kW	11kW	15kW	22kW	30kW
		500–550VAC	4kW	4kW	7.5kW	7.5kW	15kW	22kW	30kW
	Three-phase motor (AC2)	200–220VAC	2.5kW	2.5kW	4kW	5.5kW	7.5kW	11kW	15kW
		380–440VAC	4kW	4kW	7.5kW	11kW	15kW	22kW	30kW
		500–550VAC	4kW	4kW	7.5kW	7.5kW	15kW	22kW	30kW
	Inching (AC4) (Inching ratio 50%, electrical durability 0.1 million times) JIS, JEM and IEC	200–220VAC	1.5kW	1.5kW	2.2kW	3.7kW	5.5kW	7.5kW	9kW
380–440VAC		2.2kW	2.2kW	3.7kW	5.5kW	7.5kW	11kW	15kW	
Rated capacity for resistance load (AC1) (Electrical durability 0.5 million times) JIS, JEM and IEC		200–220VAC	20A	20A	32A	35A	50A	70A	80A
		380–440VAC	20A	20A	32A	35A	50A	70A	80A
Rated thermal current (Ith)		without enclosure	20A	20A	32A	35A	50A	70A	80A
Type of coil			Direct-input coil						
Characteristics of operation coil (at 20°C cold start)	Coil burden (max.)	At power-on	11W		15W		18W		22W
		After power-on	11W		15W		18W		22W
	Time constant	At power-on	28ms		45ms		55ms		60ms
		At release	28ms		45ms		55ms		60ms
	Pick-up voltage (% of rated voltage) (mean)		55%	60%	60%		55%		55%
	Drop-out voltage (% of rated voltage) (mean)		22%	23%	17%		19%		20%
	Operating time 100VDC (reference value)	At power-on	25–30ms	25–30ms	35–40ms		40–45ms		50–55ms
At release		15–20ms	10–15ms	20–25ms		20–25ms		20–25ms	
Auxiliary contact specification	Type of constant		Twin contact						
	Numbers	Standard	1N0	1N01NC	1N01NC		2N02NC		
Maximum		1N0	1N01NC	2N02NC (AX-20使用不可)		2N02NC (AX-20使用不可)			
Durability		Mechanical	10 million times						
		Electrical	1 million times						
Available voltage range of operational coil			24–220V						

Notes:

1) Rating of Auxiliary Contact

Rated operational current					Rated thermal current	Minimum rating
AC (AC15)			DC L/R≤40ms			
200–220V	380–440V	500–550V	48V	110V		
2A	1A	0.75A	0.7A	0.3A	10A	24V 10mA

- Since operating time depends on coil voltage etc., the contactor must not be applied for timing use.
- When rectifier is used in the operating power source circuit, DC side must be interrupted.  
If AC side of the circuit is interrupted, the drop-out time becomes longer because the rectifier constructs closed circuit with coil.
- As a NC contact (wrap NC contact) of H80C–H125C-G is used for changing of coil, available numbers of auxiliary contacts are reduced.  
Where marked (z) and self-holding NO contact is included in the numbers.



Non-reversible ... H  -G  
 Reversible ... H  -RG

	80C	100C	125C	150C	200C	250C	300C	400C	600C	800C
	H80C-G	H100C-G	H125C-G	H150C-G	H200C-G	H250C-G	H300C-G	H400C-G	H600C-G	H800C-G
	H80C-RG	H100C-RG	H125C-RG	H150C-RG	H200C-RG	H250C-RG	H300C-RG	H400C-RG	H600C-RG	H800C-RG
660VAC										
	80A	100A	125A	150A	180A	240A	300A	400A	600A	800A (AC2)
	80A	100A	125A	150A	180A	240A	300A	400A	600A	800A (AC2)
	72A	72A	72A	80A	145A	145A	250A	350A	500A	—
	—	—	—	—	—	—	—	—	—	—
	—	—	—	—	—	—	—	—	—	—
	19kW	25kW	30kW	37kW	45kW	60kW	75kW	110kW	150kW	—
	37kW	50kW	60kW	75kW	90kW	120kW	150kW	200kW	300kW	—
	45kW	45kW	45kW	55kW	90kW	90kW	160kW	200kW	300kW	—
	19kW	25kW	30kW	37kW	45kW	60kW	75kW	110kW	150kW	200kW
	37kW	50kW	60kW	75kW	90kW	120kW	150kW	200kW	300kW	400kW
	45kW	45kW	45kW	55kW	90kW	90kW	160kW	200kW	300kW	—
	13kW	13kW	13kW	22kW	30kW	37kW	45kW	45kW	55kW	—
	19kW	19kW	19kW	30kW	37kW	45kW	55kW	55kW	75kW	—
	120A	135A	150A	200A	260A	300A	350A	420A	600A	800A (0.1 million times)
	120A	135A	150A	200A	260A	300A	350A	420A	600A	800A (0.1 million times)
	120A	135A	150A	200A	260A	300A	350A	420A	600A	800A
Double coil										
	300W			340W	380W		1400W		1400W	
	4W			6W	7W		9W		12W	
	16ms			20ms	30ms		45ms		55ms	
	40ms			65ms	85ms		90ms		105ms	
	68%			70%	70%		70%		70%	
	20%			45%	45%		35%		35%	
	25–40ms			30–50ms	30–50ms		35–60ms		35–60ms	
	40–50ms			20–40ms	20–45ms		20–45ms		25–50ms	
Twin contact										
	2N01NC ☆			2N02NC			3N03NC		4N04NC	
	4N03NC ☆ (可逆形の場合 3N02NC)			4N04NC (可逆形の場合 3N03NC)				4N04NC		
	5 million times					5 million times			1 million times	1 million times
	1 million times					0.5 million times			0.5 million times	0.1 million times
	24–220V				100–220V					

## 4.5 Latched Electromagnetic Contactors

Item		Frame	10	11	20	25	35	50	65C
Model	AC operation	Non-reversible	H10-L	H11-L	H20-L	H25-L	H35-L	H50-L	H65C-L
		Reversible	—	H11-RL	H20-RL	H25-RL	H35-RL	H50-RL	H65C-RL
	DC operation	Non-reversible	H10-LG	H11-LG	H20-LG	H25-LG	H35-LG	H50-LG	H65C-LG
		Reversible	—	H11-RLG	H20-RLG	H25-RLG	H35-RLG	H50-RLG	H65C-RLG
Rated insulation voltage (Ui)		660VAC							
Max. rated capacity of motor	Rated operational current (AC3)	200–220VAC	12A	20A	26A	35A	50A	65A	
		380–440VAC	9A	17A	24A	32A	47A	65A	
		500–550VAC	8A	12A	12A	26A	37A	52A	
	Single-phase motor (AC3) JIS, JEM and IEC	100–110VAC	0.4kW	0.75kW	—	—	—	—	
		200–220VAC	0.75kW	—	—	—	—	—	
	Three-phase motor (AC3)	200–220VAC	2.5kW	4kW	5.5kW	7.5kW	11kW	15kW	
		380–440VAC	4kW	7.5kW	11kW	15kW	22kW	30kW	
		500–550VAC	4kW	7.5kW	7.5kW	15kW	22kW	30kW	
	Three-phase motor (AC2)	200–220VAC	2.5kW	4kW	5.5kW	7.5kW	11kW	15kW	
		380–440VAC	4kW	7.5kW	11kW	15kW	22kW	30kW	
500–550VAC		4kW	7.5kW	7.5kW	15kW	22kW	30kW		
Rated capacity for resistance load (AC1) (Electrical durability 0.5 million times) JIS, JEM and IEC		200–220VAC	20A	32A	35A	50A	70A	80A	
		380–440VAC	20A	32A	35A	50A	70A	80A	
Rated thermal current (Ith)		without enclosure	20A	32A	35A	50A	70A	80A	
Characteristics of operation coil (at 20°C cold start)	AC operation	Closing coil	Coil burden	45VA	140VA	165VA	220VA		
			Operating time (reference value) (ms)	10–15ms	15–25ms	15–25ms	15–25ms		
		Tripping coil	Coil burden	55VA	130VA	130VA	130VA		
			Operating time (reference value) (ms)	9–13ms	20–30ms	20–30ms	20–30ms		
	DC operation	Closing coil	Coil burden	50W	130W	100W	130W		
			Operating time (reference value) (ms)	10–15ms	15–25ms	15–25ms	15–25ms		
		Tripping coil	Coil burden	65W	135W	135W	135W		
			Operating time (reference value) (ms)	10–15ms	20–30ms	20–30ms	20–30ms		
Auxiliary contact specification	Type of constant		Twin contact						
	Numbers	Standard	—	1NC	1NO2NC				
		Maximum	—	1NC	3NO4NC (可逆形の場合2NO3NC)				
Mechanical interlock unit (reversible)		—	—	Provided as standard					
DIN rail mounting (non-reversible)		Provided as standard			—				
Durability	Mechanical		1 million times			0.5 million times			
	Electrical		0.5 million times			0.5 million times			
Available voltage range of operational coil		24–220V							

Notes:

1) Rating of Auxiliary Contact

Rated operational current					Rated thermal current	Minimum rating
AC (AC15)			DC L/R≤40ms			
200–220V	380–440V	500–550V	48V	110V		
2A	1A	0.75A	0.7A	0.3A	10A	24V 10mA

2) Numbers of the auxiliary contacts are not included a NO contact for cutting off power source of tripping

3) Since operating time depends on coil voltage, frequency, phase etc., the contactors must not be applied for timing use.

<AC operation>                      <DC operation>  
 Non-reversible    ... H  -L                      H  -LG  
 Reversible         ... H  -RL                      H  -RLG

	80C	100C	125C	150C	200C	250C	300C	400C	600C
	H80C-L	H100C-L	H125C-L	H150C-L	H200C-L	H250C-L	H300C-L	H400C-L	H600C-L
	H80C-RL	H100C-RL	H125C-RL	H150C-RL	H200C-RL	H250C-RL	H300C-RL	H400C-RL	H600C-RL
	H80C-LG	H100C-LG	H125C-LG	H150C-LG	H200C-LG	H250C-LG	H300C-LG	H400C-LG	H600C-LG
	H80C-RLG	H100C-RLG	H125C-RLG	H150C-RLG	H200C-RLG	H250C-RLG	H300C-RLG	H400C-RLG	H600C-RLG
	660VAC								
	80A	100A	125A	150A	180A	240A	300A	400A	600A
	80A	100A	125A	150A	180A	240A	300A	400A	600A
	72A	72A	72A	80A	145A	145A	250A	350A	500A
	—	—	—	—	—	—	—	—	—
	—	—	—	—	—	—	—	—	—
	19kW	25kW	30kW	37kW	45kW	60kW	75kW	110kW	150kW
	37kW	50kW	60kW	75kW	90kW	120kW	150kW	200kW	300kW
	45kW	45kW	45kW	55kW	90kW	90kW	160kW	200kW	300kW
	19kW	25kW	30kW	37kW	45kW	60kW	75kW	110kW	150kW
	37kW	50kW	60kW	75kW	90kW	120kW	150kW	200kW	300kW
	45kW	45kW	45kW	55kW	90kW	90kW	160kW	200kW	300kW
	120A	135A	150A	200A	260A	300A	350A	420A	600A
	120A	135A	150A	200A	260A	300A	350A	420A	600A
	120A	135A	150A	200A	260A	300A	350A	420A	600A
	700VA		400VA		480VA		2800VA		8200VA
	15–30ms		30–50ms		30–50ms		20–40ms		30–40ms
	350VA		500VA		700VA		400VA		700VA
	20–30ms		20–80ms		50–100ms		30–40ms		35–45ms
	225W		340W		380W		650W		680W
	30–40ms		30–50ms		30–50ms		40–60ms		80–100ms
	300W		600W		630W		350W		480W
	20–30ms		30–40ms		30–40ms		40–50ms		50–65ms
	Twin contact								
	1N02NC								3N03NC
	3N04NC (可逆形の場合2N03NC)						3N04NC		3N03NC
	Provided as standard								
	—								
	0.25 million times								0.25 million times
	0.1 million times								0.05 million times
	100–220V			100–220V			100–220V		

## 4.6 Contactor Relays

Model		XS4	
Numbers of contact		4 contacts	
Contact configuration (standard)		4a, 3a1b, 2a2b	
Contact configuration (maximum)		Four contacts can be added to the standard specification. Head-on 4 contacts: 4a, 3a1b, 2a2b Head-of 2 contacts: 2a, 1a1b, 2b Side-on 2 contacts: 1a1b	
Rated insulation voltage		690VAC	
Open thermoelectric current (Ith)		10A	
Rated usable current	Resistance load (AC-12)	110VAC	10A
		220VAC	8A
		440VAC	5A
		550VAC	5A
	Coil load (AC-15)	110VAC	6A
		220VAC	3A
		440VAC	1.5A
		550VAC	1.4A
	Resistance load (DC-12)	24VDC	5A
		48VDC	3A
		110VDC	2.5A
		220VDC	1A
	Coil load (DC-13)	24VDC	3A
		48VDC	1.5A
110VDC		0.55A	
220VDC		0.27A	
Minimum applicable rating		20V 5mA	
Operation coil characteristics	Coil capacity (average)	at power-on	100/90VA
		after power-on	12/11VA
	Coil loss (average)		3W
	Operating voltage (%/200 V, 60 Hz)		70%
	Release voltage (%/200 V, 60 Hz)		59%
Operating time (%/200 V, 60 Hz)	at power-on	10–20ms	
	at release	10–35ms	
IEC 35-mm rail mounting mechanism		Provided as standard	
Durability	Mechanical	8 million times	
	Electrical	0.5 million times	

### Notes:

- 1) 接点は標準ツイン接点となります。
- 2) The head-on unit and the side-on unit cannot be mounted on the same body at the same time.
- 3) Since operating time depends on coil voltage, frequency, phase etc., the contactors must not be applied for timing use.

### ■ Auxiliary Contact Unit

Model		SXH-2	SXH-4	SXS-2
Type		Head-on		Side-on
Contact configuration (standard)		2a, 1a1b, 2b	4a, 3a1b, 2a2b	1a1b
Open thermoelectric current (Ith)		10A		
Rated usable current	Resistance load (AC-12)	110VAC	10A	
		220VAC	8A	
	Coil load (AC-15)	110VAC	6A	
		220VAC	3A	
		440VAC	1.5A	
	Resistance load (DC-12)	110VDC	2.5A	
		220VDC	1A	
	Coil load (DC-13)	48VDC	1.5A	
		110VDC	0.55A	
		220VDC	0.27A	
Minimum applicable rating		20V 5mA		

### Notes:

- 1) The head-on unit and the side-on unit cannot be mounted on the same body at the same time.



Item				Numbers of contact	4 contacts		5 contacts										
Model				DC operation type		Latched type		DC operation type		Latched type							
				X4-G		X4-L		X4-LG		X5-G		X5-L					
Contact configuration				4a, 3a1b, 2a2b		3a* 2a1b 1a2b		5a, 4a1b, 3a2b, 2a3b		4a* 3a1b 2a2b 1a3b							
Rated insulation voltage				660VAC													
Rated thermal current (lth( )は3台以上密着取付のとき)				15 (3) A		15 (3) A		15 (3) A		15 (3) A							
Contact Rating				Type		AC15		200–220VAC		3A		3A					
								380–440VAC		3A		3A		3A			
								500–550VAC		2A		2A		2A		2A	
				DC L/R≤40ms		48VDC		1A		1A		1A		1A			
						110VDC		0.4A		0.4A		0.4A		0.4A			
						220VDC		0.2A		0.2A		0.2A		0.2A			
Minimum applicable rating				48V, 10mA				48V, 10mA									
Operation coil characteristics				Coil burden (max.) AC200V 50/60Hz, DC100V		at power-on		11W		—		11W		—			
						after power-on		11W		—		11W		—			
				Coil loss (average) (%/200 V, 60 Hz)				11W		—		11W		—			
				Operating voltage (%/200 V, 60 Hz)				50%		—		55%		—			
				Release voltage (%/200 V, 60 Hz)				19%		—		21%		—			
				Operating time (%/200 V, 60 Hz)				at power-on		15–25ms		—		25–30ms		—	
								at release		15–0ms		—		10–15ms		—	
				Latched type		AC operation		closing coil		Coil burden		45VA		45VA		45VA	
								Operating time (reference value)		10–15ms		10–15ms		10–15ms			
						Tripping coil		Coil burden		55VA		55VA		55VA		55VA	
Operating time (reference value)		9–13ms						9–13ms		9–13ms							
DC operation		closing coil				Coil burden		50W		50W		50W		50W			
		Operating time (reference value)				10–15ms		10–15ms		10–15ms							
Tripping coil		Coil burden		65W		65W		65W		65W		65W					
		Operating time (reference value)		10–15ms		10–15ms		10–15ms									
IEC 35-mm rail mounting mechanism				—		Provided as standard		—		—		—					
Durability				Mechanical		1 million times		1 million times		1 million times		1 million times					
				Electrical		0.5 million times		0.5 million times		0.5 million times							
Available voltage range of operational coil				24–20V		24–440V		24–220V		24–440V		24–220V					
						24–220V				24–220V							

Notes:

- 1) Numbers of the auxiliary contacts for latched type are not included a NO contact for cutting off the power source of tripping coil (marked\*).
- 2) (1) DC operation and Twin contact type (X□□-GW)
  - Contact Rating: see X□□-W
  - Characteristics of operation coil: see X□□-G
- (2) Latched and Twin contact type (X□□-LW)
  - Contact Rating: see X□□-W
  - Characteristics of operation coil: X□□-L
- 3) Since operating time depends on coil voltage, frequency, phase etc., the contactors are not applied for timing use.

## 5 STANDARD TYPE ELECTROMAGNETIC CONTACTORS AND SWITCHES

### 5.1 Coil Specifications

#### ■ Standard Specification Table of Coil

Frame	Specifications	Voltage/Frequency	Coil tap	Terminal code
8-125C		100V 50Hz/100-110V 60Hz	Common tap for 50Hz, 60Hz	A2                      A1 
		200V 50Hz/200-220V 60Hz		
		400V 50Hz/400-440V 60Hz		
150C-800C		100-110V 50Hz/60Hz		
		200-220V 50Hz/60Hz		
		400-440V 50Hz/60Hz		

#### ■ Rated Operational Voltage and Color Classification of Coil

Color of outer wrapping and lead wire (COMMON line)	Rated operational voltage and frequency	
	8-125C	
Yellow	100V 50Hz/100-110V 60Hz	
White	200V 50Hz/200-220V 60Hz	
Red	400V 50Hz/400-440V 60Hz	
Blue	Exclusive coil for all voltages* and frequencies used other than the above.	

NOTES:

1) For example, 200-220V, 60Hz includes all those of voltages between 200V and 220V. In case no special request is received, shipment will be made under the standard coil voltage indication even in case of 210V, 60Hz.

2) \*

Frame	Manufacturable voltage range
8-125C	24V-550V
150C-800C	100V-440V

### 5.2 Performance

All models of Hitachi magnetic switches and contactors conform to the international standard (IEC 60947-4-1).

Frame	Making capacity*	Breaking capacity*	Applicable operating frequency	Durability	
				Electrical	Mechanical
8-12	Not less than 10 times rated current	Not less than 8 times rated current	1200 operations per hour	2 million times	10 million times
20				2 million times	5 million times
10B, 25-200C				1 million times	5 million times
250C-600C				0.5 million times	5 million times

NOTES: Conform to category AC3 of IEC 60947-4-1

### 5.3 Application for the International Standards

Rated insulation voltage (V)	IEC 60947-4-1	BS	VDE	UL	CSA
150	All Frames	All Frames	All Frames	Authorization is required.	
250					
300					
380					
500					
600					
690 (H series: 660V)			—		

NOTES: 上表は標準形電磁接触器の適用を示します。

### 5.4 Normal Service Condition

(1) Ambient temperature:  $\frac{\text{without enclosure}}{\text{with enclosure}} \begin{cases} -5^{\circ}\text{C} - 50^{\circ}\text{C} \\ -5^{\circ}\text{C} - 40^{\circ}\text{C} \end{cases}$

(2) Relative humidity: 45% - 85%

(3) Altitude: 2,000m or lower

(4) Atmosphere: must be free from corrosive gas, combustible gas, dust, vapor, salt etc.

(5) Environment: must be free from excessive vibration or shock.

## 5.5 Selection

### ■ Application of Cases Including Inching and Plugging (Category AC4)

In equipment and machinery which include inching and plugging (negative-phase braking), make and break of large starting rush current of motor will occur frequently. Category AC4 is applied for such usage. The rating of electromagnetic contactor is AC3. However, Category AC4 can be applied by lowering the rating.

Application examples for motors when assuming that starting rush current (inching current) of the motor is about 6 times that of the rated operational current are shown in Tables 1 and 2.

**TABLE 1 INCHING (AC4)**

Motor capacity (kW)	Inching ratio 50%				Inching ratio 75–100%			
	Electrical durability 0.1 million times		Electrical durability 0.5 million times		Electrical durability 0.1 million times		Electrical durability 0.5 million times	
	200–220V	380–440V	200–220V	380–440V	200–220V	380–440V	200–220V	380–440V
0.1	HS10	HS10	HS10	HS10	HS10	HS10	HS10	HS10
0.2								
0.4							HS35	HS35
0.75			HS50	HS50				
1.5							HS20	HS20
2.2	HS35	HS25						
3.7			HS20	HS20	H65C	HS35	HS35	HS25
5.5	HS35	HS25	H80C	HS50	H65C	HS35	H150C	H65C
7.5	HS50	HS35	H150C	H65C	H80C	HS50		H200C
9	H65C	HS50		H200C			H150C	
11	H80C		H65C		H300C	H200C		H250C
13		H150C		H80C			H300C	
15	H200C		H150C		H600C	H250C		H300C
18.5		H250C		H200C			H300C	
22	H300C		H250C		H600C	H300C		H200C
30		H250C		H200C			H600C	
37	H300C		H250C		H600C	H300C		H200C
45		H600C		H300C			H600C	
55	H600C		H300C		H600C	H300C		H200C
75		—		H600C			—	

**TABLE 2 PLUGGING (AC4)**

Motor capacity (kW)	Plugging			
	Electrical durability 0.1 million times		Electrical durability 0.5 million times	
	200–220V	380–440V	200–220V	380–440V
0.2	HS10-R	HS10-R	HS10-R	HS10-R
0.4			HS20-R	HS20-R
0.75			HS35-R	HS35-R
1.5	HS20-R	HS20-R	HS50-R	HS50-R
2.2			HS35-R	HS35-R
3.7	HS35-R	HS35-R	H80C-R	HS50-R
5.5	H65C-R	HS50-R	H150C-R	H65C-R
7.5	H80C-R	H65C-R		H80C-R
11	H150C-R	H80C-R	H200C-R	H150C-R
15			H300C-R	
18.5	H200C-R	H150C-R	H400C-R	H200C-R
22	H250C-R		H600C-R	H300C-R
30	H300C-R	H200C-R		H400C-R
37	H600C-R	H300C-R	—	H600C-R
45		H600C-R	—	—

**NOTES:**

- Inching ratio (%) means  $\frac{\text{Inching operation}}{\text{Inching operation} + \text{Normal operation operation}} \times 100(\%)$  (Category AC3)
- Please enquire when using high inching frequency machine tools, hoists, cranes, etc., with an inching ratio of about 75–100%.

## ■ Application to AC Resistance Load

Category AC1 is applied when using a resistance load which does not necessitate consideration of rush current at starting such as the incandescent light, electric heater, etc.

Application of electromagnetic contactor to Category AC1 is shown in Table 3.

TABLE 3

Type	Category AC1 rating			
	Rated operational current (A)		Three-phase heater capacity (kW)	
	200-220V	380-440V	200-220V	380-440V
HS8, HS10	20 (15)	20 (15)	6 (5)	12 (10)
HS20	32 (26)	32 (26)	10 (9)	20 (18)
HS25	35 (33)	35 (33)	12 (12)	24 (24)
HS35	50 (44)	50 (44)	17 (15)	34 (30)
HS50	70 (60)	70 (60)	24 (20)	48 (40)
H65C	80 (65)	80 (65)	27 (22)	54 (45)
H80C	120 (80)	120 (80)	40 (27)	80 (55)
H100C	135 (100)	135 (100)	46 (34)	92 (69)
H125C	150 (125)	150 (125)	50 (43)	100 (86)
H150C	200 (150)	200 (150)	65 (60)	130 (100)
H200C	260 (200)	260 (200)	90 (60)	180 (120)
H250C	300 (240)	300 (240)	100 (80)	200 (160)
H300C	350 (300)	350 (300)	120 (100)	240 (200)
H400C	420 (400)	420 (400)	145 (135)	290 (270)
H600C	600 (600)	600 (600)	200 (200)	410 (410)
H800C	800	800	270	540

Notes:

- 1) The electrical durability is 0.5 million times.
- 2) Category AC1 is not applied to loads such as of mercury lamps where a large rush current flows at starting, and uses where resistance load is controlled at the primary side of the transformer.
- 3) Values of ( ) are applied to Enclosure type.

## ■ Application to Capacitor Load

力率改善用の進相コンデンサを閉路すると、回路インピーダンスに依存した大きな突入電流が流れます。コンデンサの設置による電圧、電流の歪を抑制するため直列リアクトルを設置し、

コンデンサ突入電流が10倍以下の場合と直列リアクトルがなく突入電流が20倍以下の場合についてそれぞれの適用をTABLE 4に示します。

TABLE 4

Type	三相 (6%直列リアクトル付)				三相 (直列リアクトルなし)				単相 (直列リアクトルなし) 接点は2極直列			
	200-220V		380-440V		200-220V		380-440V		200-220V		380-440V	
	kvar	A	kvar	A	kvar	A	kvar	A	kvar	A	kvar	A
H10C, H11	4.2	12	6	9	3	9	4	6	1.8	9	2.4	6
H20	6.9	20	12	17	5	14	8	12	2.8	14	4.8	12
H25	9	26	16	23	7	20	12	17	4	20	6.8	17
H35	12	35	22	32	10	29	18	26	5.5	28	10.5	26
H50	17	49	32	46	13	38	26	38	7.5	38	15	38
H65C	22	64	42	61	18	52	35	51	10	50	20	50
H80C	27	78	51	74	22	64	45	65	12	60	26	65
H100C	32	92	64	92	29	84	55	79	16	80	31	78
H125C	36	104	72	104	34	98	70	101	19	95	40	100
H150C	48	139	96	139	44	127	88	127	25	125	50	125
H200C	62	179	120	173	53	153	105	152	30	150	60	150
H250C	65	188	130	188	65	188	130	188	37	185	75	188
H300C	84	242	180	260	80	231	160	231	46	230	92	230
H400C	109	315	200	289	100	289	200	289	57	285	115	288
H600C	159	459	300	433	150	433	300	433	86	430	173	433

Notes:

- 1) 直列リアクトルが無い場合の開路時突入電流波高値はコンデンサ定格電流20倍以下で耐久性は約20万回です。
- 2) 直列リアクトル付の場合の耐久性は、AC3級定格と同一です。

## ■ Application to Star-delta Starting

スターデルタ始動は始動時にモータの結線をスター結線とし、モータの相電圧を $1/\sqrt{3}$  (約 58%) に減圧して始動し、加速後デルタ結線に切り替えて全電圧で運転を行います。

### 1. 相電流保護方式

- サーマルリレーをデルタ結線内に設置し、相電流を検出してモータを保護します。

線電流保護方式に対し、小さなRC値のサーマルリレーが適用できる (電磁開閉器セット品が使える) メリットがあります。

Star-delta starter として適用する例

Type of load	Example of load	Life
無負荷始動するもの	旋盤、ボール盤など。 バルブを閉じて始動する球体機械、うず巻ポンプなど。 シャッターを閉じて始動する空気機械、プロアなど	50万回
自乗トルク負荷 慣性負荷	流体機械および空気機械 脱水機、クランクプレスなど	5万回

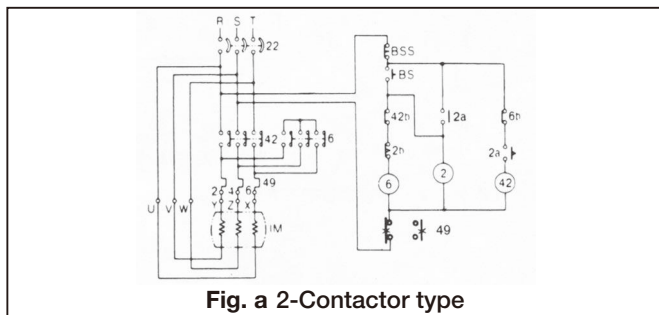
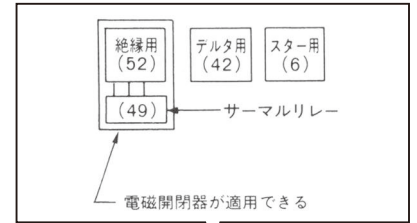
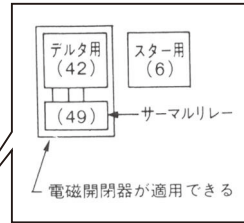

Fig. a 2-Contactor type

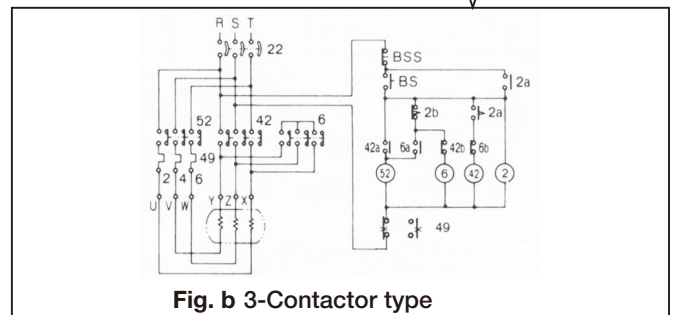

Fig. b 3-Contactor type

TABLE 5 相電流保護方式スターデルタ選定表

Voltage	Max. motor capacity (kW)	Components								
		2-Contactor type		3-Contactor type			Switch with thermal overload relay (49)			
		Contactor for starting (6)	Switch for operation (42+49)	Switch for insulation (52+49)	Contactor for operation (42)	Contactor for starting (6)	RC (A)	Adjustable range (A)	Type	
200V	5.5	H20	B) H20-TK	B) H20-TK	H20	H20	15	12-18	TR20B-2E	
	7.5		B) H25-TK	B) H25-TK	H25					
	11		B) H35-TK	B) H35-TK	H35					
	15	H25	B) H50-TK	B) H50-TK	H50	H25	28	22-34	TR50B-2E	
	18.5	H35								
	22	H50	H65C-TK	H65C-TK	H65C	H35	55	45-65	TR80B-2E	
	30		H80C-TK	H80C-TK	H80C					
	37		H100C-TK	H100C-TK	H100C					
	45	H65C	H125C-TK	H125C-TK	H125C	H65C	80	65-95	TR150B-2E	
	55		H80C	H150C-TK	H150C-TK					H150C
	75	H125C	H200C-TK	H200C-TK	H200C	H125C	1.4 (140)	(110-180)	TR250B-2E	
	90	H150C	H250C-TK	H250C-TK	H250C	H150C	2.4 (240)	(170-290)		
	110	H200C	H300C-TK	H300C-TK	H300C	H200C				
	132	H250C	H400C-TK	H400C-TK	H400C	H250C	80	65-95	TR400B-2E	
150	H300C									
400V	5.5	H20	B) H20-TK	B) H20-TK	H20	H20	6.8	5-8	TR20B-2E	
	7.5		B) H25-TK	B) H25-TK	H25					
	11		B) H35-TK	B) H35-TK	H35					
	15	H25	B) H50-TK	B) H50-TK	H50	H25	15	12-18	TR50B-2E	
	18.5									H35
	22	H35	B) H50-TK	B) H50-TK	H50	H35	20	16-24	TR50B-2E	
	30									H25
	37									H50
	45	H65C	H65C-TK	H65C-TK	H65C	H50	40	32-48	TR80B-2E	
	55									H80C-TK
	75	H80C	H100C-TK	H100C-TK	H100C	H80C	55	45-65	TR80B-2E	
	90	H100C	H125C-TK	H125C-TK	H125C	H100C	80	65-95		
	110	H125C	H150C-TK	H150C-TK	H150C	H125C	105	90-120	TR150B-2E	
	132	H200C	H200C-TK	H200C-TK	H200C	H200C	1.4 (140)	(110-170)		
	150		H250C-TK	H250C-TK	H250C					
	190	H300C	H300C-TK	H300C-TK	H300C	H300C	1.8 (180)	(140-220)	TR250B-2E	
	260		H400C-TK	H400C-TK	H400C					
						2.4 (240)	(200-80)	TR400B-2E		

Notes:

- 1) ご使用に当たっては、適用モータ電流値  $\times 0.58$  の他に、サーマルリレー調整つまみの電流値を合わせてください。
- 2) 記載RC値は標準モータの場合の例です。適用モータ電流値  $\times 0.58$  の値に最も近いRC値を選定してください。



## 2. 線電流保護方式

- サーマルリレーを主回路に設置し、線電流を検出してモータを保護します。
- スター用として電磁接触器、デルタ用として電磁接触器およびサーマルリレー、3接触器方式の場合は、さらに絶縁用として電磁接触器を **TABLE 6** から選んでください。  
なお、接続図例を **Fig. a**、**Fig. b** に示します。

### ● 留意事項

電動機停止中は電動機巻線に電圧が印加されない  
**3接触器方式**をお奨めします。なお2接触器方式の場合、一次側に開閉器 (FFB等) を設置し、電動機停止中は必ず開閉器を開路しておくことをお奨めします。

Code (No.) of Components

No.	Components	Code	Components
2	Timer	IM	Motor
6	Contact for starting	BS	Push button (start)
22	Fuse-free Circuit breaker	BSS	Push button (stop)
42	Contact for operation	a	コイル付勢により開路する接点
49	Thermal overload relay	b	コイル付勢により開路する接点
52	Contact for insulation		

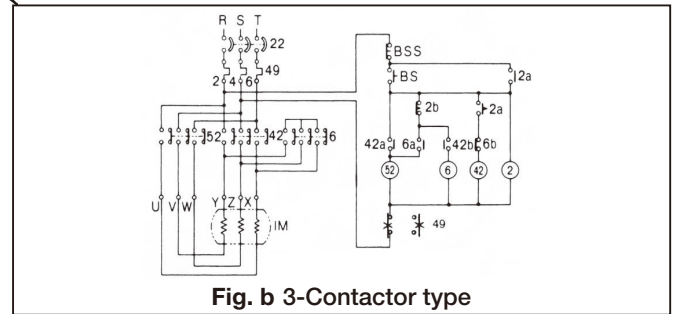
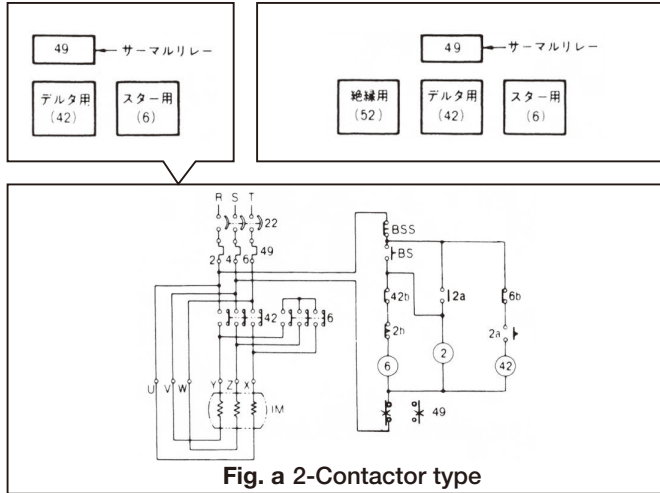

**TABLE 6** 線電流保護方式スターデルタ選定表

Voltage	Max. motor capacity (kW)	Components					
		Contact for insulation (52)	Contact for starting (6)	Contact for operation (42)	Thermal overload relay (49)	RC (A)	Adjustable range (A)
200V	5.5	H20	H20	H20	TR25B-2E タンドクトリツケ用	20	16-24
	7.5	H25		H25	TR50B-2E	28	22-34
	11	H35		H35		40	32-48
	15	H50	H25	H50	TR80B-2E	55	45-65
	18.5					67	55-80
	22	H65C	H35	H65C	TR150B-2E タンドクトリツケ用	80	65-95
	30	H80C				H50	H80C
	37	H100C	H65C	H100C	TR400B-2E タンドクトリツケ用	130	110-150
	45	H125C				H125C	1.4(140)
	55	H150C	H80C	H150C	TR400B-2E タンドクトリツケ用	1.8(180)	(140-220)
	75	H200C				H125C	2.4(240)
	90	H250C	H200C	H250C	TR400B-2E タンドクトリツケ用	3.0(300)	(240-360)
	110	H300C				H300C	3.8(380)
	132	H400C	H250C	H400C	TR400B-2E タンドクトリツケ用	5.0(500)	(400-600)
150	H300C						
400V	5.5	H20	H20	H20	TR20B-2E	9	7-11
	7.5					15	12-18
	11				H25	H25	H25
	15	28	22-34				
	18.5	H35	H25	H35	TR50B-2E	40	32-48
	22					H50	H35
	30	67	55-80				
	37	H65C	H50	H65C	TR150B-2E タンドクトリツケ用	80	65-95
	45					105	90-120
	55	H80C	H65C	H80C	TR400B-2E タンドクトリツケ用	130	110-150
	75	H100C				H100C	1.4(140)
	90	H125C	H200C	H125C	TR400B-2E タンドクトリツケ用	1.8(180)	(140-220)
	110	H150C				H125C	2.4(240)
	132	H200C	H200C	H200C	TR400B-2E タンドクトリツケ用	3.0(300)	(240-360)
	150	H250C				H250C	3.8(380)
	190	H300C	H300C	H300C	TR400B-2E タンドクトリツケ用	5.0(500)	(400-600)
260	H400C	H400C					

Notes: 適用モータ電流値が上記のRC値と異なる場合は、調整つまみをまわして合わせてください。

## 5.6 Cautions

### ■ Allowable Installation Angle

Normal installation is made on the perpendicular plane as shown in Fig. b. As shown in Fig. a, the installation position with an inclination of up to 15° to the left and right and back and forth is permissible.

Limited to models of frames 8C–125C, side installation, in the condition where it is turned 90° in counterclockwise direction from the normal installation position, can also be made as shown in Fig. c, but in unavoidable cases. However, its life will be shortened by about 20%.



Fig. a Allowable installation angle

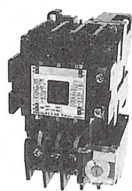

Fig. b Normal installation

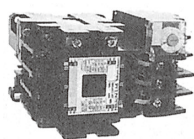

Fig. c Side installation

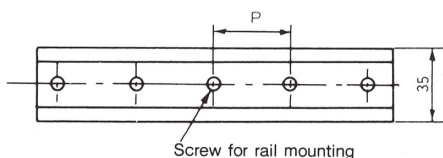
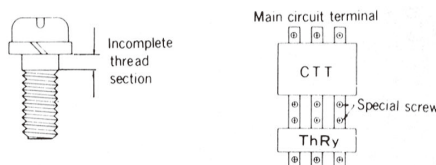

Fig. d



### ■ Cautions of Rail Mounting Type

- (1) Interval of screws for rail mounting  
Interval of screws for rail mounting – as shown in Fig. d – shall be as follows.
  - Contactor relays and 8C–12 frame:  $P \geq 300\text{mm}$
  - 20–50 frame:  $P \geq 200\text{mm}$
- (2) Mounting space of switches  
Mounting space of switches – as shown in Fig. e – shall be as follows.
  - Contactor relay:  $l \geq 0\text{mm}$
  - Contactor switch:  $l \geq 5\text{mm}$
- (3) Side installation is not allowed as shown in Fig. f.

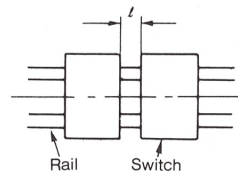

Fig. e

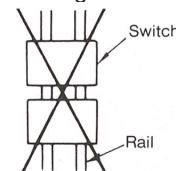

Fig. f

### ■ Applicable Wires and Suitable Tightening Torques







Frame	Specifications		Main circuit					Operating circuit					Contactor				
	Motor capacity 200V Class (kW)	Rated operational current 200V Class (A)	Terminal screw (mm)		Connectable wire (mm <sup>2</sup> )	Maximum width of usable solderless terminal (mm)	Suitable tightening torque (N·m)		Terminal screw (mm)		Connectable wire (mm <sup>2</sup> )	Maximum width of usable solderless terminal (mm)	Suitable tightening torque (N·m)		Mounting screw		Suitable tightening torque (N·m)
			Electro- magnetic contactor	Thermal overload relay			Electro- magnetic contactor	Thermal overload relay	Electro- magnetic contactor	Thermal overload relay			Electro- magnetic contactor	Thermal overload relay	Screw diameter (mm)	Number of screws	
8	2.2	11	M3.5	(ø1.6) 2	7.8	1	M3.5	(ø1.6) 2	7.8	1	M4	2	1.5				
10	2.5	12	M3.5	(ø1.6) 2	7.8	1	M3.5	(ø1.6) 2	7.8	1	M4	2	1.5				
20	4	20	M4	(ø2.) 3.5	9	1.5	M3.5	(ø1.6) 2	7.8	1	M4	2	1.5				
25	5.5	26	M5	(ø2.6) 8	10	3.5	M3.5	(ø1.6) 2	7.8	1	M4	2	1.5				
35	7.5	35	M5	(ø3.2) 14	12.5	3.5	M3.5	(ø1.6) 2	7.8	1	M4	2	1.5				
50	11	50	M5	14	12.5	3.5	M3.5	(ø1.6) 2	7.8	1	M4	2	1.5				
65C	15	65	M6	22	16.5	5	M3.5	(ø1.6) 2	7.8	1	M4	2	1.5				
80C	19	80	M6	60	22	5	M3.5	(ø1.6) 2	7.8	1	M5	2	3.5				
100C	25	100	M8 bolt	60	22	14	M3.5	(ø1.6) 2	7.8	1	M5	2	3.5				
125C	30	125	M8 bolt	60	22	14	M3.5	(ø1.6) 2	7.8	1	M6	2	5				
150C	37	150	M8 bolt	80	27	14	M3.5	(ø1.6) 2	7.8	1	M6	2	5				
200C	45	180	M10 bolt	—	150	37	25	—	M3.5	(ø1.6) 2	7.8	1	M8 bolt	4	14		
250C	60	240	M10 bolt	—	150	37	25	—	M3.5	(ø1.6) 2	7.8	1	M8 bolt	4	14		
300C	75	300	M12 bolt	—	200	44	45	—	M3.5	(ø1.6) 2	7.8	1	M8 bolt	4	14		
400C	110	400	M12 bolt	—	200	44	45	—	M3.5	(ø1.6) 2	7.8	1	M8 bolt	4	14		
600C	150	600	M12 bolt	—	325	55	45	—	M4 M3.5 (coil)	M3.5	(ø1.6) 2	7.8	1.5 1	1	M10 bolt	4	25
800C	200 (AC2)	800 (AC2)	M16 bolt (M12×2)	—	325	55	45	—	M4 M3.5 (coil)	—	(ø1.6) 2	7.8	1.5 1	—	M10 bolt	4	25

Notes:

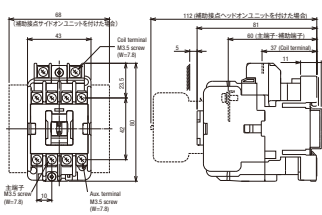
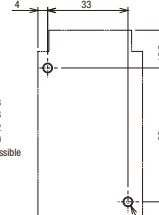
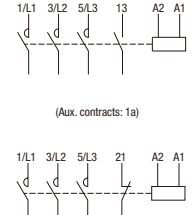
- 1) Except for certain special cases, the following are used for wiring of operating circuit electric wires, circuits of auxiliary contacts, etc.
  - Single wire: 1.6–600V polyvinyl chloride wire
  - Standard wire: 1.25 or 2 mm<sup>2</sup> 600V polyvinyl chloride wire
- 2) 適正締付トルクの旧単位(kgf·cm)値は上表の10倍となります。

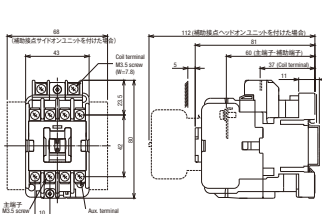
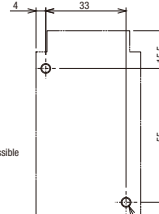
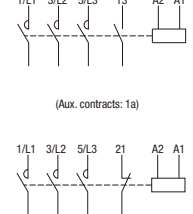
# 5.7 Appearance and Dimensions

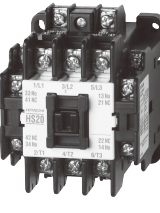
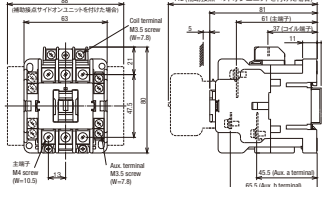
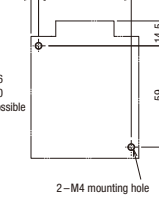
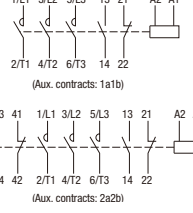
## ■ Non-Reversible Electromagnetic Contactors without Enclosure

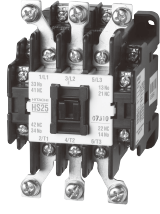
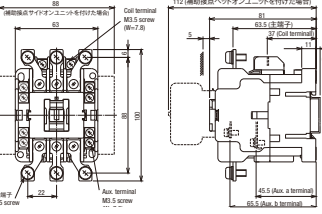
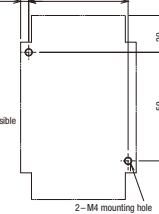
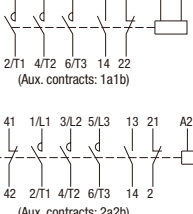
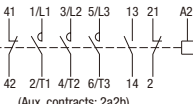
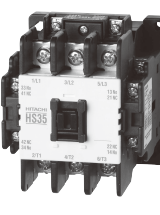
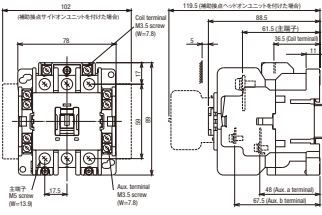
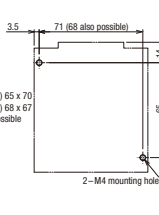
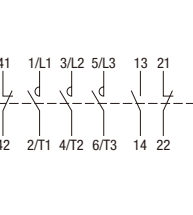
Appearance	Dimensions (mm) (Product mass)	Drilling plan	Contact arrangement	Terminal section dimensions (mm)							
 <p><b>HS8</b></p>	 <p>(0.34kg)</p>	 <p>30 x 48 34 x 48 34 x 52 35 x 50 also possible</p> <p>2-M4 mounting hole</p>	 <p>(Aux. contracts: 1a)</p>  <p>(Aux. contracts: 1b)</p>	<table border="1"> <tr><td rowspan="3">Main circuit</td><td>Terminal screw</td><td rowspan="3">M3.5</td></tr> <tr><td>Terminal dimensions</td><td>A</td></tr> <tr><td></td><td>B</td></tr> </table>	Main circuit	Terminal screw	M3.5	Terminal dimensions	A		B
				Main circuit		Terminal screw		M3.5			
Terminal dimensions	A										
	B										
<table border="1"> <tr><td rowspan="3">Operating circuit</td><td>Terminal screw</td><td rowspan="3"></td></tr> <tr><td>Terminal dimensions</td><td>A</td></tr> <tr><td></td><td>B</td></tr> </table>	Operating circuit	Terminal screw		Terminal dimensions	A		B				
Operating circuit		Terminal screw									
		Terminal dimensions			A						
		B									
 <p><b>HS10</b></p>	 <p>(0.34kg)</p>	 <p>30 x 48 34 x 48 34 x 52 35 x 50 also possible</p> <p>2-M4 mounting hole</p>	 <p>(Aux. contracts: 1a)</p>  <p>(Aux. contracts: 1b)</p>	<table border="1"> <tr><td rowspan="3">Main circuit</td><td>Terminal screw</td><td rowspan="3">M3.5</td></tr> <tr><td>Terminal dimensions</td><td>A</td></tr> <tr><td></td><td>B</td></tr> </table>	Main circuit	Terminal screw	M3.5	Terminal dimensions	A		B
				Main circuit		Terminal screw		M3.5			
Terminal dimensions	A										
	B										
<table border="1"> <tr><td rowspan="3">Operating circuit</td><td>Terminal screw</td><td rowspan="3"></td></tr> <tr><td>Terminal dimensions</td><td>A</td></tr> <tr><td></td><td>B</td></tr> </table>	Operating circuit	Terminal screw		Terminal dimensions	A		B				
Operating circuit		Terminal screw									
		Terminal dimensions			A						
		B									
 <p><b>HS20</b></p>	 <p>(0.41kg)</p>	 <p>54 x 56 54 x 60 also possible</p> <p>2-M4 mounting hole</p>	 <p>(Aux. contracts: 1a1b)</p>  <p>(Aux. contracts: 2a2b)</p>	<table border="1"> <tr><td rowspan="3">Main circuit</td><td>Terminal screw</td><td rowspan="3">M3.5</td></tr> <tr><td>Terminal dimensions</td><td>A</td></tr> <tr><td></td><td>B</td></tr> </table>	Main circuit	Terminal screw	M3.5	Terminal dimensions	A		B
				Main circuit		Terminal screw		M3.5			
Terminal dimensions	A										
	B										
<table border="1"> <tr><td rowspan="3">Operating circuit</td><td>Terminal screw</td><td rowspan="3"></td></tr> <tr><td>Terminal dimensions</td><td>A</td></tr> <tr><td></td><td>B</td></tr> </table>	Operating circuit	Terminal screw		Terminal dimensions	A		B				
Operating circuit		Terminal screw									
		Terminal dimensions			A						
		B									
 <p><b>HS25</b></p>	 <p>(0.47kg)</p>	 <p>54 x 56 54 x 60 also possible</p> <p>2-M4 mounting hole</p>	 <p>(Aux. contracts: 1a1b)</p>  <p>(Aux. contracts: 2a2b)</p>	<table border="1"> <tr><td rowspan="3">Main circuit</td><td>Terminal screw</td><td rowspan="3">M3.5</td></tr> <tr><td>Terminal dimensions</td><td>A</td></tr> <tr><td></td><td>B</td></tr> </table>	Main circuit	Terminal screw	M3.5	Terminal dimensions	A		B
				Main circuit		Terminal screw		M3.5			
Terminal dimensions	A										
	B										
<table border="1"> <tr><td rowspan="3">Operating circuit</td><td>Terminal screw</td><td rowspan="3"></td></tr> <tr><td>Terminal dimensions</td><td>A</td></tr> <tr><td></td><td>B</td></tr> </table>	Operating circuit	Terminal screw		Terminal dimensions	A		B				
Operating circuit		Terminal screw									
		Terminal dimensions			A						
		B									
 <p><b>HS35</b></p>	 <p>(0.53kg)</p>	 <p>(60 →) 65 x 70 (64 →) 68 x 67 also possible</p> <p>2-M4 mounting hole</p>		<table border="1"> <tr><td rowspan="3">Main circuit</td><td>Terminal screw</td><td rowspan="3">M3.5</td></tr> <tr><td>Terminal dimensions</td><td>A</td></tr> <tr><td></td><td>B</td></tr> </table>	Main circuit	Terminal screw	M3.5	Terminal dimensions	A		B
				Main circuit		Terminal screw		M3.5			
Terminal dimensions	A										
	B										
<table border="1"> <tr><td rowspan="3">Operating circuit</td><td>Terminal screw</td><td rowspan="3"></td></tr> <tr><td>Terminal dimensions</td><td>A</td></tr> <tr><td></td><td>B</td></tr> </table>	Operating circuit	Terminal screw		Terminal dimensions	A		B				
Operating circuit		Terminal screw									
		Terminal dimensions			A						
		B									

Model	Dimensions					Minimum mounting space (mm)				
	D	E	F	G	H	D	E	F	G	H
HS8										
HS10										
HS20										
HS25										
HS35										

**Mounting space**

Note: Do not operate with the cover removed  
(Check by removing the cover only when inspecting the contact and always be sure to securely push in the cover after checking).

**Terminal section dimensions**

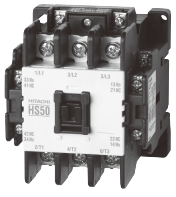
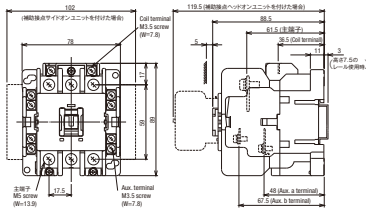
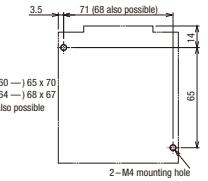
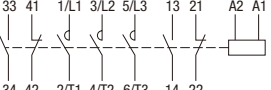
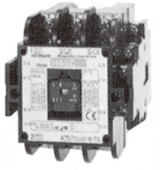
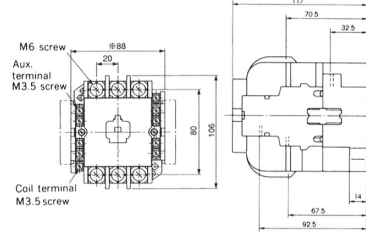
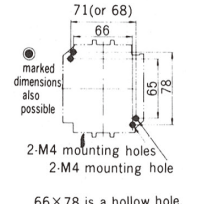
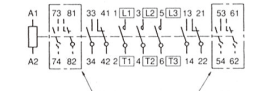
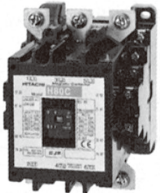
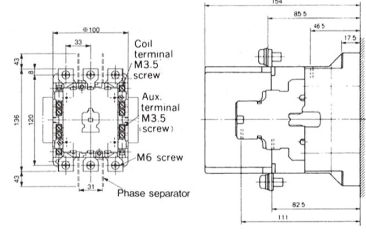
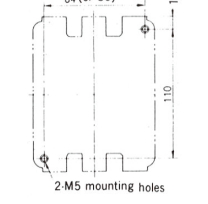
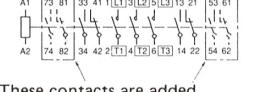
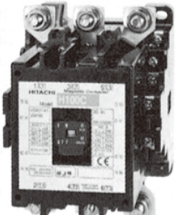
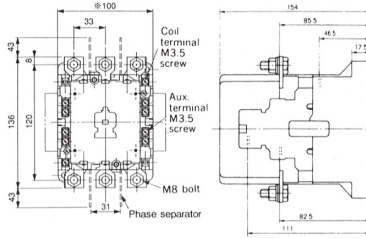
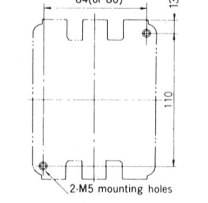
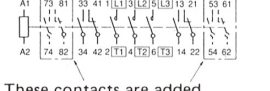
Appearance	Dimensions (mm) (Product mass)	Drilling plan	Contact arrangement	Terminal section dimensions (mm)														
 <p><b>HS50</b></p>	 <p>(0.53kg)</p>	 <p>2-M mounting hole</p>		<table border="1"> <tr> <td rowspan="3">Main circuit</td> <td>Terminal screw</td> <td>M3.5</td> </tr> <tr> <td rowspan="3">Terminal dimensions</td> <td>A</td> </tr> <tr> <td>B</td> </tr> <tr> <td>C</td> </tr> <tr> <td rowspan="3">Operating circuit</td> <td>Terminal screw</td> <td></td> </tr> <tr> <td rowspan="3">Terminal dimensions</td> <td>A</td> </tr> <tr> <td>B</td> </tr> <tr> <td>C</td> </tr> </table>	Main circuit	Terminal screw	M3.5	Terminal dimensions	A	B	C	Operating circuit	Terminal screw		Terminal dimensions	A	B	C
Main circuit	Terminal screw	M3.5																
	Terminal dimensions	A																
		B																
C																		
Operating circuit	Terminal screw																	
	Terminal dimensions	A																
		B																
C																		
 <p><b>H65C</b></p>	 <p>(1.2kg)</p>	 <p>2-M4 mounting holes 2-M4 mounting hole 66×78 is a hollow hole.</p>	 <p>These contacts are added in case of aux. contacts 4N04NC.</p>	<table border="1"> <tr> <td rowspan="3">Main circuit</td> <td>Terminal screw</td> <td>M6</td> </tr> <tr> <td rowspan="3">Terminal dimensions</td> <td>A</td> </tr> <tr> <td>B</td> </tr> <tr> <td>C</td> </tr> <tr> <td rowspan="3">Operating circuit</td> <td>Terminal screw</td> <td>M3.5</td> </tr> <tr> <td rowspan="3">Terminal dimensions</td> <td>A</td> </tr> <tr> <td>B</td> </tr> <tr> <td>C</td> </tr> </table>	Main circuit	Terminal screw	M6	Terminal dimensions	A	B	C	Operating circuit	Terminal screw	M3.5	Terminal dimensions	A	B	C
Main circuit	Terminal screw	M6																
	Terminal dimensions	A																
		B																
C																		
Operating circuit	Terminal screw	M3.5																
	Terminal dimensions	A																
		B																
C																		
 <p><b>H80C</b></p>	 <p>(2.0kg)</p>	 <p>2-M5 mounting holes</p>	 <p>These contacts are added in case of aux. contacts 4N04NC.</p>	<table border="1"> <tr> <td rowspan="3">Main circuit</td> <td>Terminal screw</td> <td>M6</td> </tr> <tr> <td rowspan="3">Terminal dimensions</td> <td>A</td> </tr> <tr> <td>B</td> </tr> <tr> <td>C</td> </tr> <tr> <td rowspan="3">Operating circuit</td> <td>Terminal screw</td> <td>M3.5</td> </tr> <tr> <td rowspan="3">Terminal dimensions</td> <td>A</td> </tr> <tr> <td>B</td> </tr> <tr> <td>C</td> </tr> </table>	Main circuit	Terminal screw	M6	Terminal dimensions	A	B	C	Operating circuit	Terminal screw	M3.5	Terminal dimensions	A	B	C
Main circuit	Terminal screw	M6																
	Terminal dimensions	A																
		B																
C																		
Operating circuit	Terminal screw	M3.5																
	Terminal dimensions	A																
		B																
C																		
 <p><b>H100C, H125C</b></p>	 <p>(2.2kg)</p>	 <p>2-M5 mounting holes</p>	 <p>These contacts are added in case of aux. contacts 4N04NC.</p>	<table border="1"> <tr> <td rowspan="3">Main circuit</td> <td>Terminal screw</td> <td>M8 bolt</td> </tr> <tr> <td rowspan="3">Terminal dimensions</td> <td>A</td> </tr> <tr> <td>B</td> </tr> <tr> <td>C</td> </tr> <tr> <td rowspan="3">Operating circuit</td> <td>Terminal screw</td> <td>M3.5</td> </tr> <tr> <td rowspan="3">Terminal dimensions</td> <td>A</td> </tr> <tr> <td>B</td> </tr> <tr> <td>C</td> </tr> </table>	Main circuit	Terminal screw	M8 bolt	Terminal dimensions	A	B	C	Operating circuit	Terminal screw	M3.5	Terminal dimensions	A	B	C
Main circuit	Terminal screw	M8 bolt																
	Terminal dimensions	A																
		B																
C																		
Operating circuit	Terminal screw	M3.5																
	Terminal dimensions	A																
		B																
C																		

Model	Dimensions					Minimum mounting space (mm)				
	D	E	F	G	H	D	E	F	G	H
HS50										
H65C	1	15	5	10	5					
H80C	1	15	10	10	10					
H100C, H125C	1	15	10	10	10					

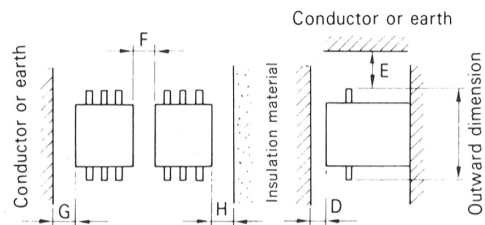

**Mounting space**

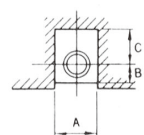

**Terminal section dimensions**



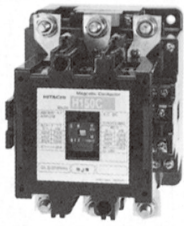
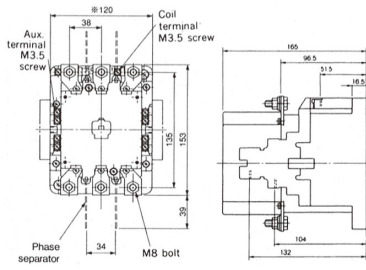
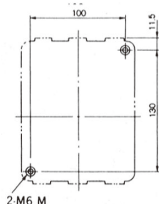
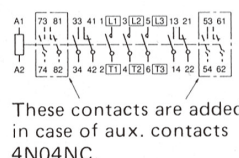

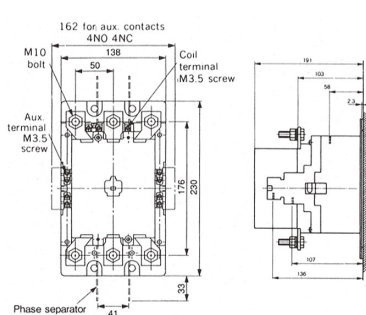
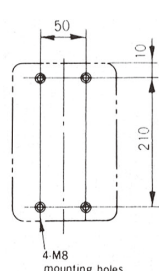
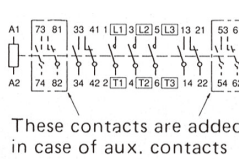
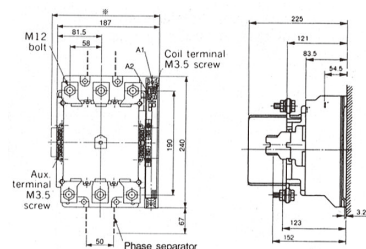
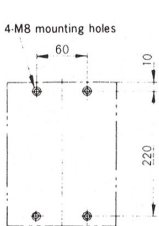
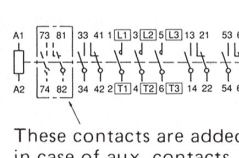
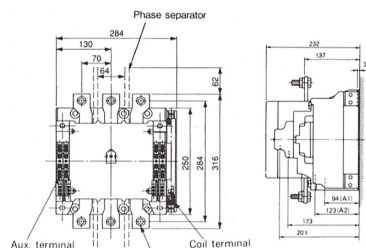
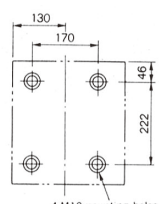
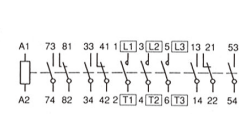
Appearance	Dimensions (mm) (Product mass)	Drilling plan	Contact arrangement	Terminal section dimensions (mm)										
 <p><b>H150C</b></p>	 <p>(3.3kg)</p>	 <p>2 M6 M mounting holes</p>	 <p>These contacts are added in case of aux. contacts 4N04NC.</p>	<table border="1"> <tr> <td rowspan="3">Main circuit</td> <td>Terminal screw</td> <td>M8 bolt</td> </tr> <tr> <td rowspan="3">Terminal dimensions</td> <td>A</td> <td>27</td> </tr> <tr> <td>B</td> <td>10</td> </tr> <tr> <td>C</td> <td>9.5</td> </tr> </table>	Main circuit	Terminal screw	M8 bolt	Terminal dimensions	A	27	B	10	C	9.5
				Main circuit		Terminal screw	M8 bolt							
Terminal dimensions	A	27												
	B	10												
	C	9.5												
<table border="1"> <tr> <td rowspan="3">Operating circuit</td> <td>Terminal screw</td> <td>M3.5</td> </tr> <tr> <td rowspan="3">Terminal dimensions</td> <td>A</td> <td>7.8</td> </tr> <tr> <td>B</td> <td>6</td> </tr> <tr> <td>C</td> <td>4.5</td> </tr> </table>	Operating circuit	Terminal screw	M3.5	Terminal dimensions	A	7.8	B	6	C	4.5				
Operating circuit		Terminal screw	M3.5											
		Terminal dimensions	A		7.8									
	B		6											
C	4.5													
 <p><b>H200C, H250C</b></p>	 <p>(5.5kg)</p>	 <p>4 M8 mounting holes</p>	 <p>These contacts are added in case of aux. contacts 4N04NC.</p>	<table border="1"> <tr> <td rowspan="3">Main circuit</td> <td>Terminal screw</td> <td>M10 bolt</td> </tr> <tr> <td rowspan="3">Terminal dimensions</td> <td>A</td> <td>37</td> </tr> <tr> <td>B</td> <td>12.5</td> </tr> <tr> <td>C</td> <td>16</td> </tr> </table>	Main circuit	Terminal screw	M10 bolt	Terminal dimensions	A	37	B	12.5	C	16
				Main circuit		Terminal screw	M10 bolt							
Terminal dimensions	A	37												
	B	12.5												
	C	16												
<table border="1"> <tr> <td rowspan="3">Operating circuit</td> <td>Terminal screw</td> <td>M3.5</td> </tr> <tr> <td rowspan="3">Terminal dimensions</td> <td>A</td> <td>7.8</td> </tr> <tr> <td>B</td> <td>6</td> </tr> <tr> <td>C</td> <td>4.5</td> </tr> </table>	Operating circuit	Terminal screw	M3.5	Terminal dimensions	A	7.8	B	6	C	4.5				
Operating circuit		Terminal screw	M3.5											
		Terminal dimensions	A		7.8									
	B		6											
C	4.5													
<p><b>H300C, H400C</b></p>	 <p>(9.7kg)</p>	 <p>4 M8 mounting holes</p>	 <p>These contacts are added in case of aux. contacts 4N04NC.</p>	<table border="1"> <tr> <td rowspan="3">Main circuit</td> <td>Terminal screw</td> <td>M12 bolt</td> </tr> <tr> <td rowspan="3">Terminal dimensions</td> <td>A</td> <td>44</td> </tr> <tr> <td>B</td> <td>15</td> </tr> <tr> <td>C</td> <td>20</td> </tr> </table>	Main circuit	Terminal screw	M12 bolt	Terminal dimensions	A	44	B	15	C	20
				Main circuit		Terminal screw	M12 bolt							
Terminal dimensions	A	44												
	B	15												
	C	20												
<table border="1"> <tr> <td rowspan="3">Operating circuit</td> <td>Terminal screw</td> <td>M3.5</td> </tr> <tr> <td rowspan="3">Terminal dimensions</td> <td>A</td> <td>7.8</td> </tr> <tr> <td>B</td> <td>6</td> </tr> <tr> <td>C</td> <td>4.5</td> </tr> </table>	Operating circuit	Terminal screw	M3.5	Terminal dimensions	A	7.8	B	6	C	4.5				
Operating circuit		Terminal screw	M3.5											
		Terminal dimensions	A		7.8									
	B		6											
C	4.5													
<p><b>H600C</b></p>	 <p>(22kg)</p>	 <p>4 M10 mounting holes</p>		<table border="1"> <tr> <td rowspan="3">Main circuit</td> <td>Terminal screw</td> <td>M12 bolt</td> </tr> <tr> <td rowspan="3">Terminal dimensions</td> <td>A</td> <td>55</td> </tr> <tr> <td>B</td> <td>16</td> </tr> <tr> <td>C</td> <td>28</td> </tr> </table>	Main circuit	Terminal screw	M12 bolt	Terminal dimensions	A	55	B	16	C	28
				Main circuit		Terminal screw	M12 bolt							
Terminal dimensions	A	55												
	B	16												
	C	28												
<table border="1"> <tr> <td rowspan="3">Operating circuit</td> <td>Terminal screw</td> <td>M4</td> </tr> <tr> <td rowspan="3">Terminal dimensions</td> <td>A</td> <td>9</td> </tr> <tr> <td>B</td> <td>7.2</td> </tr> <tr> <td>C</td> <td>5</td> </tr> </table>	Operating circuit	Terminal screw	M4	Terminal dimensions	A	9	B	7.2	C	5				
Operating circuit		Terminal screw	M4											
		Terminal dimensions	A		9									
	B		7.2											
C	5													

Type	Dimensions	Minimum mounting space (mm)				
		D	E	F	G	H
H150C		1	15	10	10	10
H200C, H250C		1	20	10	10	10
H300C, H400C		1	30	10	10	10
H600C		1	50	10	10	10

**Mounting space**

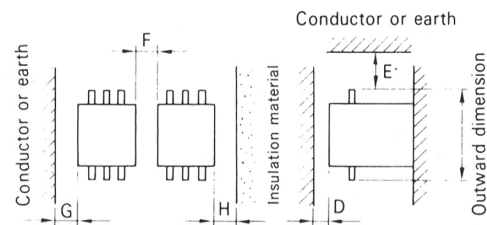

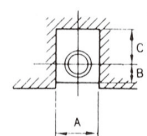

**Terminal section dimensions**



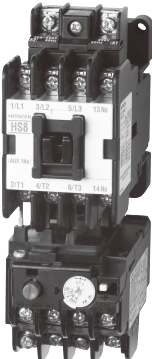
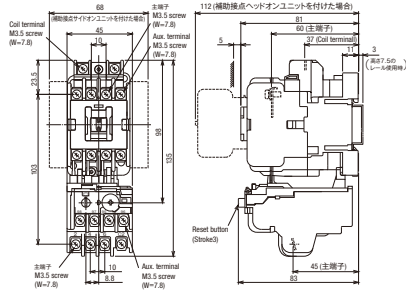
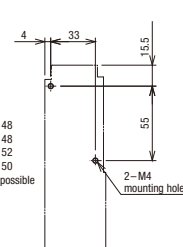
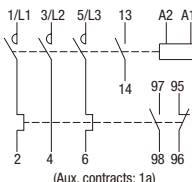
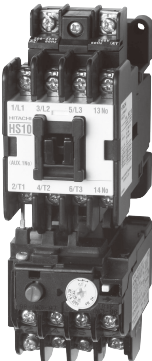
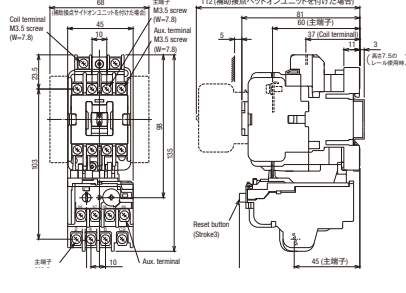
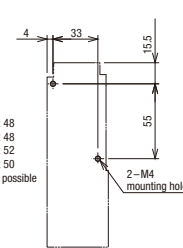
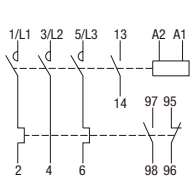

■ Non-Reversible Electromagnetic Switches without Enclosure

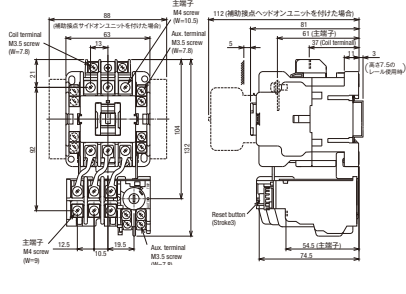
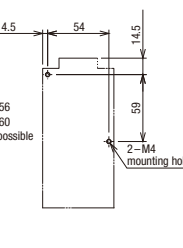
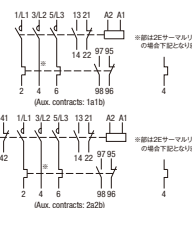
Appearance	Dimensions (mm) (Product mass)	Drilling plan	Contact arrangement	Terminal section dimensions (mm)			
				Electro-magnetic contactor	Thermal overload relay		
 <p><b>HS8-T</b></p>	 <p>(0.45kg)</p>	 <p>30 x 48 34 x 48 34 x 52 35 x 50 also possible</p>	 <p>(Aux. contracts: 1a)</p>	Main circuit	Terminal screw		
					Terminal dimensions	A	
B							
Terminal dimensions	C						
	Operating circuit	Terminal screw					
		Terminal dimensions	A				
B							
C							
 <p><b>HS10-T</b></p>	 <p>(0.45kg)</p>	 <p>30 x 48 34 x 48 34 x 52 35 x 50 also possible</p>	 <p>(Aux. contracts: 1a)</p>	Main circuit	Terminal screw		
					Terminal dimensions	A	
B							
Terminal dimensions	C						
	Operating circuit	Terminal screw					
Terminal dimensions		A					
		B					
C							
 <p><b>HS20-T</b></p>	 <p>(0.57kg)</p>	 <p>54 x 56 54 x 60 also possible</p>	 <p>(Aux. contracts: 1a1b) (Aux. contracts: 2a2b)</p>	Main circuit	Terminal screw		
					Terminal dimensions	A	
B							
Terminal dimensions	C						
	Operating circuit	Terminal screw					
Terminal dimensions		A					
		B					
C							

Type	Dimensions					Minimum mounting space (mm)				
	D	E	F	G	H	D	E	F	G	H
HS8-T										
HS10-T										
HS20-T										

Mounting space

Terminal section dimensions

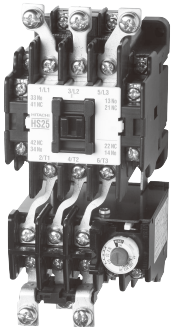
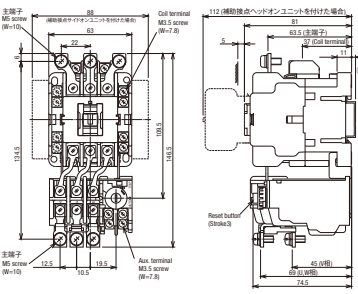
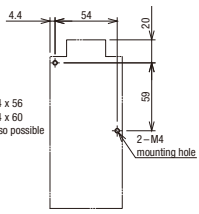
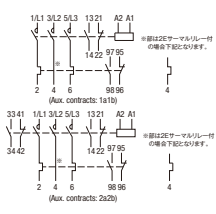
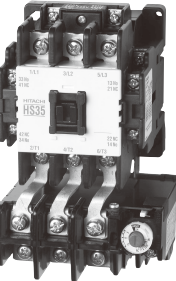
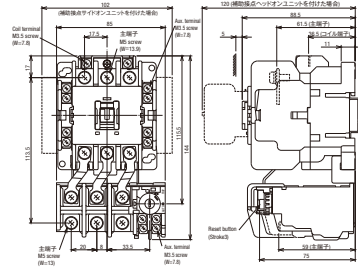
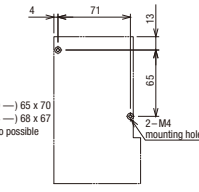
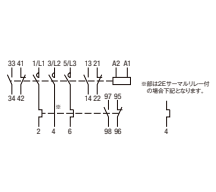
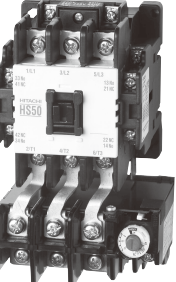
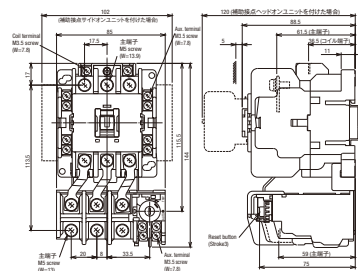
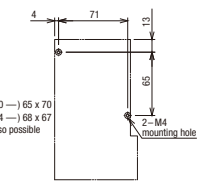
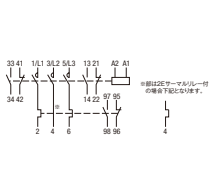
Appearance	Dimensions (mm) (Product mass)	Drilling plan	Contact arrangement	Terminal section dimensions (mm)	
				Electro-magnetic contactor	Thermal overload relay
 <p><b>HS25-T</b></p>	 <p>(0.63kg)</p>	 <p>54 x 56 54 x 60 also possible</p> <p>2-M4 mounting hole</p>		Main circuit	Terminal screw
				Terminal dimensions	A
 <p><b>HS35-T</b></p>	 <p>(0.79kg)</p>	 <p>(60 —) 65 x 70 (64 —) 68 x 67 also possible</p> <p>2-M4 mounting hole</p>		Main circuit	Terminal screw
				Terminal dimensions	A
 <p><b>HS50-T</b></p>	 <p>(0.79kg)</p>	 <p>(60 —) 65 x 70 (64 —) 68 x 67 also possible</p> <p>2-M4 mounting hole</p>		Main circuit	Terminal screw
				Terminal dimensions	A

Type	Dimensions	Minimum mounting space (mm)				
		D	E	F	G	H
HS25-T						
HS35-T						
HS50-T						

**Mounting space**

**Terminal section dimensions**

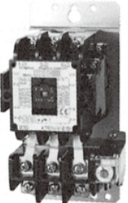
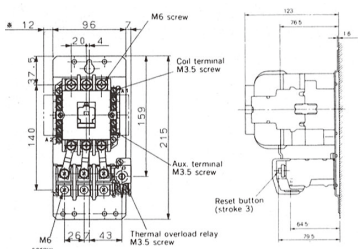
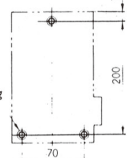
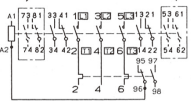
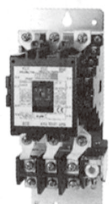
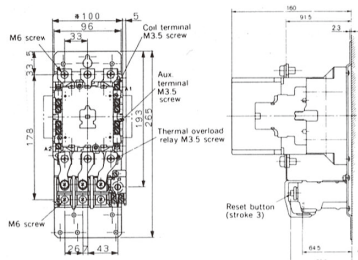
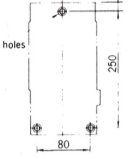
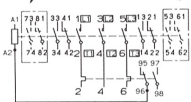
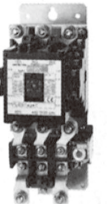
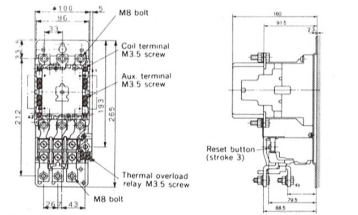
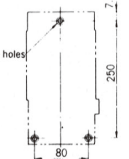
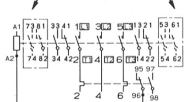
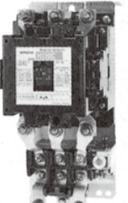
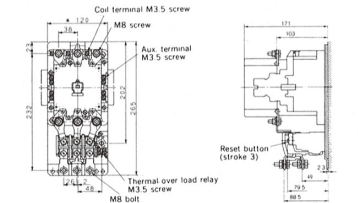
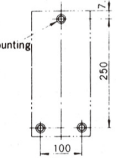
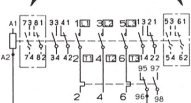
Appearance	Dimensions (mm) (Product mass)	Drilling plan	Contact arrangement	Terminal section dimensions (mm)			
				Terminal screw	Electro-magnetic contactor	Thermal overload relay	
 <p><b>H65C-T</b></p>	 <p>(1.9kg)</p>	 <p>3-M5 mounting holes</p>	 <p>Aux. contacts 4N04NC is also available.</p>	Main circuit	Terminal screw	M6	M6
					Terminal dimensions	A	16.5
B	8	8.5					
Operating circuit	Terminal screw	M3.5	M3.5				
	Terminal dimensions	A	7.8	7.8			
		B	5.5	4			
C	4.5	4.5					
 <p><b>H80C-T</b></p>	 <p>(2.8kg)</p>	 <p>3-M5 mounting holes</p>	 <p>Aux. contacts 4N04NC is also available.</p>	Main circuit	Terminal screw	M6	M6
					Terminal dimensions	A	22
B	8	8.5					
Operating circuit	Terminal screw	M3.5	M3.5				
	Terminal dimensions	A	7.8	7.8			
		B	5	4			
C	4.5	4.5					
 <p><b>H100C-T H125C-T</b></p>	 <p>(3.0kg)</p>	 <p>3 M5 mounting holes</p>	 <p>Aux. contacts 4N04NC is also available.</p>	Main circuit	Terminal screw	M8 bolt	M8 bolt
					Terminal dimensions	A	22
B	8	10					
Operating circuit	Terminal screw	M3.5	M3.5				
	Terminal dimensions	A	7.8	7.8			
		B	5	4			
C	4.5	4.5					
 <p><b>H150C-T</b></p>	 <p>(3.9kg)</p>	 <p>3-M6 mounting hole</p>	 <p>Aux. contacts 4N04NC is also available.</p>	Main circuit	Terminal screw	M8 bolt	M8 bolt
					Terminal dimensions	A	27
B	10	10					
Operating circuit	Terminal screw	M3.5	M3.5				
	Terminal dimensions	A	7.8	7.8			
		B	6	4			
C	4.5	4.5					

Type	Dimensions					Minimum mounting space (mm)				
	D	E	F	G	H	D	E	F	G	H
H65C-T	1	15	5	10	5	1	15	5	10	5
H80C-T	1	15	10	10	10	1	15	10	10	10
H100C-T H125C-T H150C-T	1	15	10	10	10	1	15	10	10	10

**Mounting space**

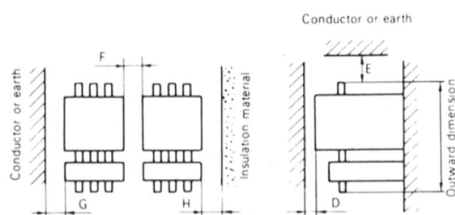

**Terminal section dimensions**

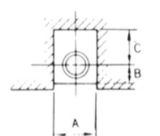



## ■ Reversible Electromagnetic Contactors without Enclosure

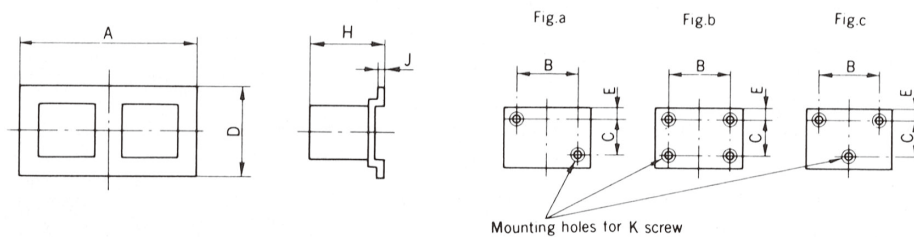

Model	Dimensions (mm)				Drilling plan (mm)					Mass (kg)
	A	D	H	J	Fig.	B	C	E	K	
HS10-R	84	71.5	95.5	17	a	73	54	5.5	2-M4	0.62
HS20-R	172	90	101.5	1.6	c	155	75	7.5	3-M4	1.2
HS25-R	172	100	101.5	1.6	c	155	75	7.5	3-M4	1.3
HS35-R	200	120	114	1.6	c	180	100	7.5	3-M5	2
HS50-R	200	120	114	1.6	c	180	100	7.5	3-M5	2
H65C-R	200	120	123	1.6	c	180	100	7.5	3-M5	2.9
H80C-R	240	170	160	1.6	c	220	150	10	3-M6	5.0
H100C-R H125C-R	240	170	160	1.6	c	220	150	10	3-M6	5.1
H150C-R	280	200	171	2.3	c	260	150	10	3-M6	6.2
H200C-R H250C-R	330	290	198	3.2	c	300	260	15	3-M8	14
H300C-R H400C-R	385	300	244	3.2	c	340	270	15	3-M8	25
H600C-R	578	316	258	25	b	480	278	19	4-M10	53
H800C-R	578	380	258	25	b	480	278	51	4-M10	53

## ■ Reversible Electromagnetic Switches without Enclosure

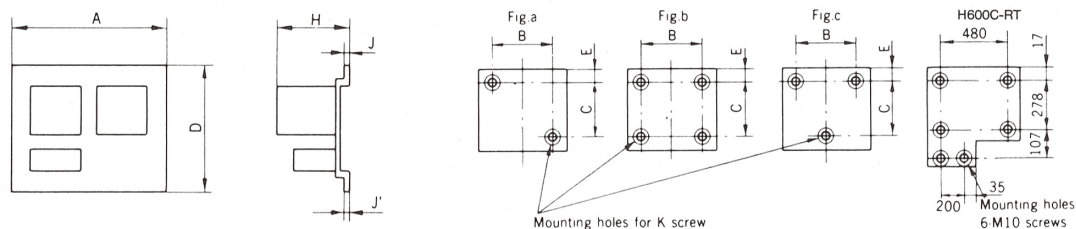

Model	Dimensions (mm)				Drilling plan (mm)					Mass (kg)
	A	D	H	J (J')	Fig.	B	C	E	K	
HS10-RT	84	128	95.5	17	a	73	54	5.5	2-M4	0.68
HS20-RT	172	135	101.5	1.6	c	155	75	7.5	3-M4	1.45
HS25-RT	172	144	101.5	1.6	c	155	75	7.5	3-M4	1.5
HS35-RT	200	158	114	1.6	c	180	100	7.5	3-M5	2.4
HS50-RT	200	158	114	1.6	c	180	100	7.5	3-M5	2.4
H65C-RT	200	186	123	1.6	c	180	170	7.5	3-M5	3.1
H80C-RT	240	228	160	1.6	c	220	210	10	3-M6	5.8
H100C-RT H125C-RT	240	247	160	1.6	c	220	210	10	3-M6	6.4
H150C-RT	280	277	171	2.3	c	260	240	10	3-M6	9.2
H200C-RT H250C-RT	330	341	198	3.2	c	300	260	15	3-M8	18
H300C-RT H400C-RT	385	360	244	3.2	c	340	270	15	3-M8	30
H600C-RT	578	453	258	25	—	—	—	—	—	58



## ■ Electromagnetic Switches without Enclosure

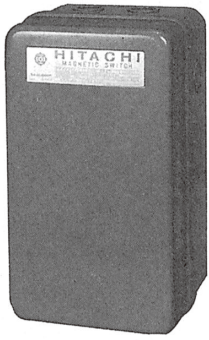

SHS35-T

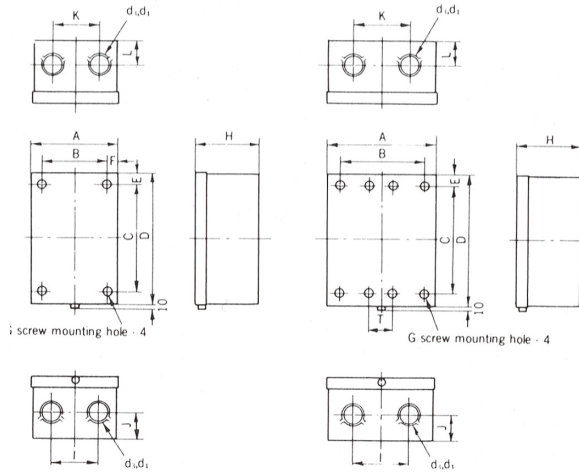

Color of enclosure
Munsell Code
5Y7/1

Frame	Model	Mass (kg)	Dimensions (mm)														
			A	B	C	D	E	F	G	H	I	J	K	L	T	d <sub>1</sub>	d <sub>2</sub>
8	*1 SHS8-T	0.68	85	65	140	165	12.5	7.5	M4×4	112	35	25	35	25	—	22	—
10	*1 SHS10-T	0.68	85	65	140	165	12.5	7.5	M4×4	112	35	25	35	25	—	22	—
20	SHS20-T	1.4	110	75	140	175	17.5	17.5	M5×4	114	35	30	35	30	—	22	—
25	SHS25-T	2.6	150	105	210	255	22.5	22.5	M5×4	130	50	40	50	40	—	22	28
35	SHS35-T	2.8															
50	SHS50-T	2.8															
65C	SH65C-T	4.6	206	160	290	336	23	23	M6×4	165	100	80	100	100	—	35	45
80C	*2 SH80C-T	5.1															
100C	*2 SH100C-T	7.5	285	185	385	560	88	50	M8×4	225	120	95	120	120	—	55	65
125C	*2 SH125C-T	12															
150C	*2 SH150C-T	13															
200C	*2 SH200C-T	14															
250C	*2 SH250C-T	14.5															
300C	*2 SH300C-T	25	340	208	515	690	63	66	M10×4	258	160	107	160	107	—	62	78
400C	*2 SH400C-T	25															
600C	*2 SH600C-T	55															
10B	B)SH10B-RT	1.5	110	75	140	175	17.5	17.5	M5×4	114	35	30	35	30	—	22	—
10	SHS10-RT	2.0	160	130	135	167	16	15	M4×4	97	90	25	100	25	—	22	—
20	SHS20-RT	2.3	195	160	140	175	17.5	17.5	M5×4	116.5	80	30	120	30	—	22	—
25	SHS25-RT	4.3	235	190	210	255	22.5	22.5	M5×4	130	120	40	140	40	—	22	28
35	SHS35-RT	4.5															
50	SHS50-RT	4.5															
65C	SH65C-RT	8.5	340	270	290	336	23	35	M6×4	165	100	80	100	100	—	35	45
80C	SH80C-RT	10.5															
100C	SH100C-RT	13	460	365	385	560	88	48	M8×4	225	120	95	120	120	—	55	65
125C	SH125C-RT	24															
150C	SH150C-RT	24															
200C	SH200C-RT	29															
250C	SH250C-RT	29															
300C	SH300C-RT	53	604	474	515	690	64	58	M10×8	258	160	107	160	107	58	62	78
400C	SH400C-RT	53															
600C	SH600C-RT	115															

- Notes:  
 1) \*1 With plastic enclosure (Other frames: steel enclosure)  
 1) \*2 With phase barrier as standard.

# 6 THERMAL OVERLOAD RELAYS

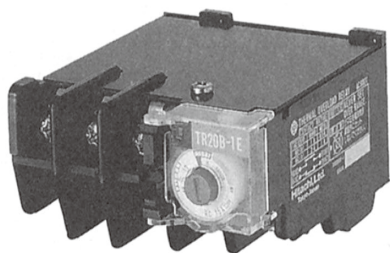

TR20B-1E

### <Features>

- 1. IEC Standard Satisfied**  
These thermal overload relays conform to the IEC Standard, and provide perfect motor protection.
- 2. Automatic and manual reset**  
Automatic and manual reset can be easily set with a screwdriver.
- 3. Easy to Use**  
All controls are located on the front. A trip indicator is provided.

### ■ Type

- 1E Thermal Overload Relay...standard relay with overload protection
- 2E Thermal Overload Relay...relay with overload and single phasing protection (same size as 1E relay)

## 6.1 Construction

Labels for 1E diagram: Button for reset and change of reset methods, Current adjust knob, N.O. fixed contact, N.O. moving contact, Temperature compensating bimetal, Trip bar, Test trip lever, Trip indicator, N.C. moving contact, N.C. fixed contact, Line side terminal, Load side terminal, Heater, Bimetal.

**Internal Construction of 1E Thermal Overload Relay**

Notes: Test trip shall be done by operating Test trip lever only, Trip indicator must not be operated.

Labels for 2E diagram: Differential lever (C), Trip bar (A), Trip bar (B).

**Internal Construction of 2E Thermal Overload Relay**  
(External construction is exactly the same as the standard type)

### <2E THERMAL OVERLOAD RELAY OPERATING MECHANISM>

The bending difference between on-phase and off-phase bimetals is available for protection of single phase failure.

<b>Three phase action</b>	Trip bar A, trip bar B and differential lever C move to the left as one unit as if they were one trip bar, and open the contact. This movement is same as that of the conventional thermal overload relay.
<b>Single phase action</b>	Trip bar B does not move due to the off-phase bimetal and trip bar A only moves to the left. At this movement, the differential lever C revolves counter-clock-wise and opens the contact.

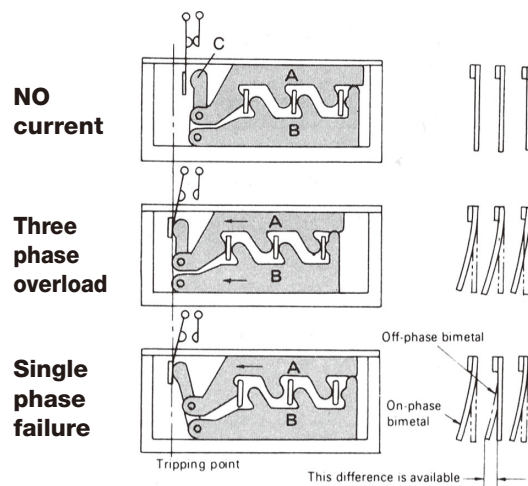

## 6.2 Tripping Characteristics

### ■ Standard (1E) Thermal Overload Relay

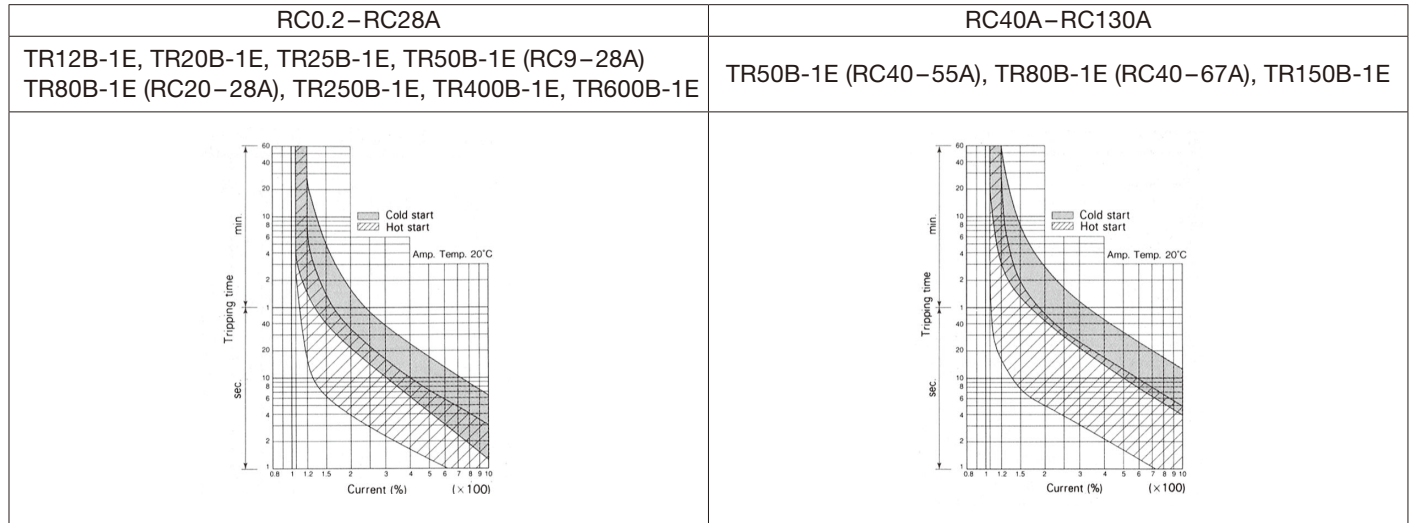

### ■ 2E Thermal Overload Relay

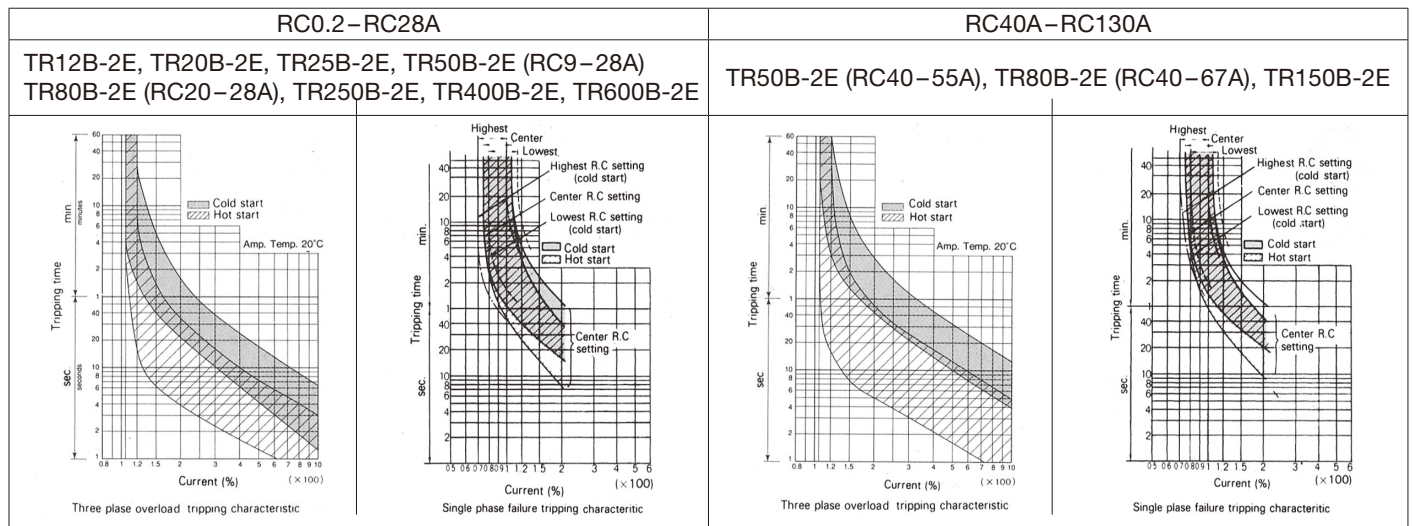

**Cold Start:** When overcurrent flows in a start where the thermal relay bimetals are not affected by current.

**Hot Start:** When overcurrent flows where the thermal relay bimetals are heated by current during motor running or restart.

### ■ Ambient Temperature Characteristics

The tripping characteristics are approximately constant under any ambient temperature so that compensating calculation is not necessary.

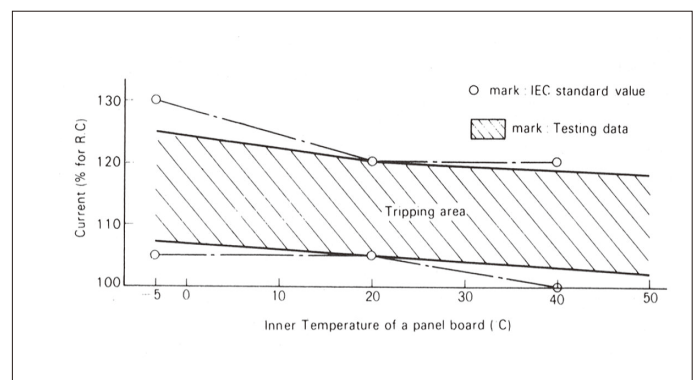

## 6.3 Application

### ■ Standard (1E) Thermal Overload Relay

HITACHI three phase squirrel-cage motor 4P for general purpose				Thermal overload relay		
500V 50Hz	400V 50Hz (60Hz)	380V 50Hz	200V 50Hz (60Hz)	RC (A)		Applicable range for each Model
				Center value	Adjustable range	
				0.2	0.16–0.24	TR12B-1E TR20B-1E
				0.3	0.22–0.38	
				0.5	0.38–0.62	
				0.8	0.6–1.0	
0.4kW 1.0A	0.4kW 1.1A (1.0A)	0.4kW 1.3A	0.2kW 1.2A (1.1A)	1.2	0.9–1.5	
0.75kW 1.5A			0.3kW 1.6A (1.5A)	1.4	1.1–1.8	
1.5kW 2.6A	0.75kW 1.9A (1.7A)	0.75kW 2.0A	0.4kW 2.3A (2.0A)	2.4	1.7–2.9	
2.2kW 3.7A	1.5kW 3.3A (3.0A)	1.5kW 3.5A	0.75kW 3.5A (3.2A)	3.8	2.8–4.4	
	2.2W 4.5A (4.2A)	2.2kW 4.8A		5	4–6	
3.7kW 5.8A	3.7kW 7.2A (7.0A)	3.7kW 7.5A	1.5kW 6.5A (6.0A)	6.8	5–8	
5.5kW 8.4A			2.2W 9.0A (8.5A)	9	7–11	
7.5kW 11.5A	5.5kW 11.5A (10.5A)	5.5kW 11A		11	9–13	TR25B-1E TR50B-1E
11kW 16A	7.5kW 14A (13.5A)	7.5kW 14.5A	3.7kW 14.5A (14A)	15	12–18	
15kW 22A	11kW 20A (19.5A)	11kW 21A	5.5kW 23A (21A)	20	16–24	TR80B-1E
				22	18–26	
18.5kW 27A	15kW 26A (26A)	15kW 28A	7.5kW 28A (27A)	28	22–34	RC22A = TR25B-1E only
22kW 32A	18.5kW 34A (32A)	18.5kW 35A	11kW 42A (40A)	40	32–48	
30kW 42A	22kW 39A (37A)	22kW 42A		40	32–48	TR150B-1E
				55	45–65	
37kW 52A	30kW 55A (52A)	30kW 55A	15kW 55A (52A)	55	45–65	TR250B-1E TR400B-1E TR600B-1E
	37kW 68A (65A)	37kW 68A	18.5kW 68A (65A)	67	55–80	
	45kW 80A (80A)	45kW 85A	22kW 82A (78A)	80	65–95	TR20B-1E with CT (ratio 100:1)
	55kW 98A (95A)	55kW 100A	30kW 110A (105A)	105	90–120	
	75kW 130A (130A)		37kW 135A (130A)	130	110–150	TR250B-1E TR400B-1E TR600B-1E
	90kW 160A (155A)		45kW 165A (160A)	1.4 (140)	(110–180)	
	110kW 190A (185A)		55kW 195A (190A)	2.4 (140)	(170–290)	
	132kW 225A (220A)		75kW 260A (260A)	3.8 (380)	(280–440)	
			110kW 380A (370A)	5 (500)	(400–600)	
			132kW 450A (440A)			

Notes:

- 1) Be sure to adjust the setting current on the adjusting knob of the thermal overload relay to the rated current value (RC) of the motor employed (The setting current must be within indicated value.).
- 2) The figure in the parenthesis of center value (RC) is the current of primary side.

### ■ Standards for Thermal Overload Relay

The standard (1E) thermal overload relay and 2E thermal overload relay conform to the JIS, JEM and IEC standards in the table.

Standard	JIS C8201-4-1				JEM 1356				IEC 60947-4-1					
	Ambient temperature	Non-operation	Operation		Ambient temperature	Non-operation	Operation		Ambient temperature	Non-operation	Operation			
Overload relay operation	Standard type and 2E thermal overload relays	40°C	100%	120% within 2hours		40°C	100%	120% within 2hours		40°C	100%	120% within 2hours		
		20°C	105%	120% within 2hours		20°C	105%	120% within 2hours		20°C	105%	120% within 2hours		
		-5°C	105%	130% within 2hours		-5°C	105%	130% within 2hours		-5°C	105%	130% within 2hours		
		20°C	100%	150% within 2minutes (Class10A) within 4minutes (Class10) within 8minutes (Class20)		20°C	100%	200% within 2minutes		20°C	100%	150% within 2minutes (Class10A) within 4minutes (Class10) within 8minutes (Class20)		
Phase-failure operation	Standard type thermal overload relays	—	—	—		20°C	3 elements 2 elements	100% 100% 100% (2 poles)	132% (2 poles only) 144% (1 pole only) 144% (1 pole only)	within 2 hours	20°C	105% (All poles)	1 pole 0% and 132% to balance poles	within 2 hours
		2E thermal overload relays	20°C	100% (2 poles) 90% (1 pole)	115% (2 poles) 0% (1 pole)	within 2 hours	20°C	90% (1 pole)	115% (2 poles) 0% (1 pole)		20°C	100% (2 poles) 90% (1 pole)	115% (2 poles) 0% (1 pole)	

Notes: Values (%) in the table indicate multiples against the rated current.

## ■ 2E Thermal Overload Relay

HITACHI three phase squirrel-cage motor 4P for general purpose				Thermal overload relay		
500V 50Hz	400V 50Hz (60Hz)	380V 50Hz	200V 50Hz (60Hz)	RC (A)		Applicable range for each type
				Center value	Adjustable range	
				0.2	0.16-0.24	TR12B-2E TR20B-2E
				0.3	0.24-0.36	
				0.4	0.32-0.48	
				0.5	0.4-0.6	
				0.6	0.5-0.7	
				0.8	0.7-0.9	
0.4kW 1.0A				1.0	0.8-1.2	
	0.4kW 1.1A (1.0A)	0.4kW 1.3A	0.2kW 1.2A (1.1A)	1.2	1.0-1.4	
0.75kW 1.5A			0.3kW 1.6A (1.5A)	1.4	1.1-1.7	
	0.75kW 1.9A (1.7A)			1.8	1.4-2.2	
1.5kW 2.6A		0.75kW 2.0A	0.4kW 2.3A (2.0A)	2.4	2.0-2.8	
				3.0	2.4-3.6	
2.2kW 3.7A	1.5kW 3.3A (3.0A)	1.5kW 3.5A	0.75kW 3.5A (3.2A)	3.8	3.0-4.5	
3.7kW 5.8A	2.2kW 4.5A (4.2A)	2.2kW 4.8A		5.0	4.0-6.0	
	3.7kW 7.2A (7.0A)	3.7kW 7.5A	1.5kW 6.5A (6.0A)	6.8	5.5-8.0	
5.5kW 8.4A			2.2kW 9.0A (8.5A)	9.0	7.0-11	
7.5kW 11.5A	5.5kW 11.5A (10.5A)	5.5kW 11A		11	9-13	
11kW 16A	7.5kW 14A (13.5A)	7.5kW 14.5A	3.7kW 14.5A (14A)	15	12-18	
15kW 22A	11kW 20A (19.5A)	11kW 21A	5.5kW 23A (21A)	20	16-24	
				22	18-26	
18.5kW 27A	15kW 26A (26A)	15kW 28A	7.5kW 28A (27A)	28	22-34	
22kW 32A	18.5kW 34A (32A)	18.5kW 35A	11kW 42A (40A)	40	32-48	
30kW 42A	22kW 39A (37A)	22kW 42A		40	32-48	
				55	45-65	
37kW 52A	30kW 55A (52A)	30kW 55A	15kW 55A (52A)	55	45-65	
	37kW 68A (65A)	37kW 68A	18.5kW 68A (65A)	67	55-80	
	45kW 80A (80A)	45kW 85A	22kW 82A (78A)	80	65-95	
	55kW 98A (95A)	55kW 100A	30kW 110A (105A)	105	90-120	
	75kW 130A (130A)		37kW 135A (130A)	130	110-150	
	90kW 160A (155A)		45kW 165A (160A)	1.4 (140)	(110-170)	
	110kW 190A (185A)		55kW 195A (190A)	1.8 (180)	(140-220)	
	132kW 225A (220A)		75kW 260A (260A)	2.4 (240)	(200-280)	
			90kW 320A (310A)	3.0 (300)	(240-360)	
			110kW 380A (370A)	3.8 (380)	(300-450)	
			132kW 450A (440A)	5 (500)	(400-600)	

Notes:

- 1) Be sure to adjust the setting current on the adjusting knob of the thermal overload relay to the rated current value (RC) of the motor employed (The setting current must be within indicated value).
- 2) The figure in the parenthesis of center value (RC) is the current of primary side.



## ■ Application for Single-phase Motor

Single-phase motor 100V		Standard type (1E) thermal overload relay			Thermal overload relay application method	
Capacity (kW)	Hitachi single-phase motor current (A) (Reference)	Thermal overload relay RC value (A)		Type application range		
		Center value	Setting current width			
0.035	1.2-1.4	1.4	1.1-1.8	TR12B-1E (RC 1.4-11.4) TR20B-1E (RC 1.4-15A)		
0.065	2.2-2.5	2.4	1.7-2.9			
0.1	3.0-3.8	3.8	2.8-4.4			
0.2	4.1-6.3					
0.25	5.4-6.7					
0.3	6.4-7.1	6.8	5.8			
0.4	5.8-9.6					
0.55	8-9.5	9	7-11			
		11	9-13			
0.75	10.5-15.5	15	12-18			

Notes: Set the current value of the thermal overload relay with adjusting knob after confirming the current of the applying motor.

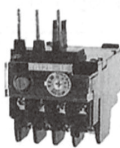
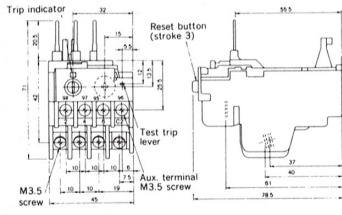
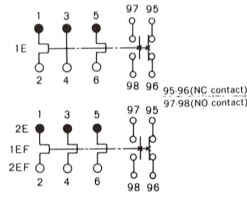
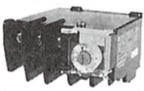
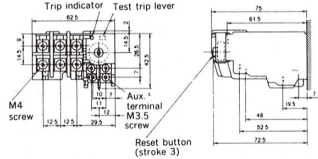
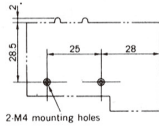
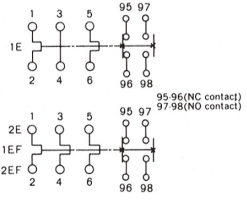
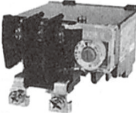
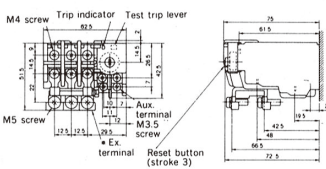
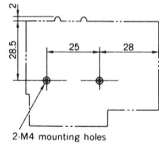
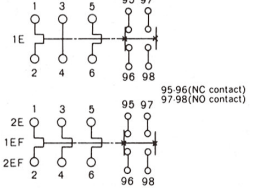
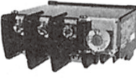
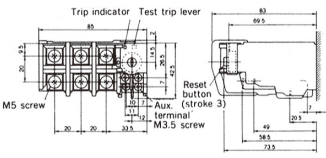
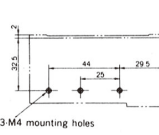
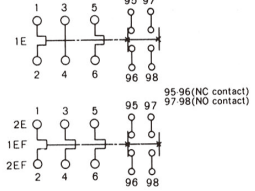

# 6.4 Appearance and Dimensions

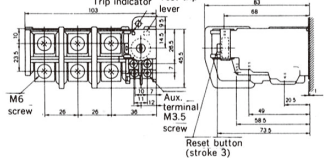
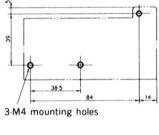
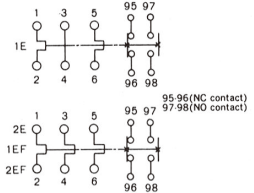

Appearance	Dimensions (mm) (Product mass)	Drilling plan	Contact arrangement	Terminal section dimensions (mm)							
 <p><b>TR12B-1E</b> <b>TR12B-2E</b> <b>TR12B-1EF</b> <b>TR12B-2EF</b></p>	 <p>(0.1kg)</p>			<table border="1"> <tr> <td rowspan="3">Main circuit</td> <td>Terminal screw</td> <td>M3.5</td> </tr> <tr> <td rowspan="3">Terminal dimensions</td> <td>A 7.8</td> </tr> <tr> <td>B 6</td> </tr> <tr> <td>C 4.5</td> </tr> </table>	Main circuit	Terminal screw	M3.5	Terminal dimensions	A 7.8	B 6	C 4.5
				Main circuit		Terminal screw	M3.5				
Terminal dimensions	A 7.8										
	B 6										
	C 4.5										
<table border="1"> <tr> <td rowspan="3">Operating circuit</td> <td>Terminal screw</td> <td>M3.5</td> </tr> <tr> <td rowspan="3">Terminal dimensions</td> <td>A 7.8</td> </tr> <tr> <td>B 4</td> </tr> <tr> <td>C 4.5</td> </tr> </table>	Operating circuit	Terminal screw	M3.5	Terminal dimensions	A 7.8	B 4	C 4.5				
Operating circuit		Terminal screw	M3.5								
		Terminal dimensions	A 7.8								
	B 4										
C 4.5											
 <p><b>TR20B-1E</b> <b>TR20B-2E</b> <b>TR20B-1EF</b> <b>TR20B-2EF</b></p>	 <p>(0.15kg)</p>	 <p>2 M4 mounting holes</p>		<table border="1"> <tr> <td rowspan="3">Main circuit</td> <td>Terminal screw</td> <td>M4</td> </tr> <tr> <td rowspan="3">Terminal dimensions</td> <td>A 9 (9)</td> </tr> <tr> <td>B 5 (7.4)</td> </tr> <tr> <td>C 5 (5)</td> </tr> </table>	Main circuit	Terminal screw	M4	Terminal dimensions	A 9 (9)	B 5 (7.4)	C 5 (5)
				Main circuit		Terminal screw	M4				
Terminal dimensions	A 9 (9)										
	B 5 (7.4)										
	C 5 (5)										
<table border="1"> <tr> <td rowspan="3">Operating circuit</td> <td>Terminal screw</td> <td>M3.5</td> </tr> <tr> <td rowspan="3">Terminal dimensions</td> <td>A 7.8</td> </tr> <tr> <td>B 4</td> </tr> <tr> <td>C 4.5</td> </tr> </table>	Operating circuit	Terminal screw	M3.5	Terminal dimensions	A 7.8	B 4	C 4.5				
Operating circuit		Terminal screw	M3.5								
		Terminal dimensions	A 7.8								
	B 4										
C 4.5											
 <p><b>TR25B-1E</b> <b>TR25B-2E</b> <b>TR25B-1EF</b> <b>TR25B-2EF</b></p>	 <p>(0.17kg)</p>	 <p>2 M4 mounting holes</p>		<table border="1"> <tr> <td rowspan="3">Main circuit</td> <td>Terminal screw</td> <td>M5 (M4)</td> </tr> <tr> <td rowspan="3">Terminal dimensions</td> <td>A 10 (9)</td> </tr> <tr> <td>B 6 (7.4)</td> </tr> <tr> <td>C 8.5 (5)</td> </tr> </table>	Main circuit	Terminal screw	M5 (M4)	Terminal dimensions	A 10 (9)	B 6 (7.4)	C 8.5 (5)
				Main circuit		Terminal screw	M5 (M4)				
Terminal dimensions	A 10 (9)										
	B 6 (7.4)										
	C 8.5 (5)										
<table border="1"> <tr> <td rowspan="3">Operating circuit</td> <td>Terminal screw</td> <td>M3.5</td> </tr> <tr> <td rowspan="3">Terminal dimensions</td> <td>A 7.8</td> </tr> <tr> <td>B 4</td> </tr> <tr> <td>C 4.5</td> </tr> </table>	Operating circuit	Terminal screw	M3.5	Terminal dimensions	A 7.8	B 4	C 4.5				
Operating circuit		Terminal screw	M3.5								
		Terminal dimensions	A 7.8								
	B 4										
C 4.5											
 <p><b>TR50B-1E</b> <b>TR50B-2E</b> <b>TR50B-1EF</b> <b>TR50B-2EF</b></p>	 <p>(0.25kg)</p>	 <p>3 M4 mounting holes</p>		<table border="1"> <tr> <td rowspan="3">Main circuit</td> <td>Terminal screw</td> <td>M5</td> </tr> <tr> <td rowspan="3">Terminal dimensions</td> <td>A 13 (13)</td> </tr> <tr> <td>B 6.5 (10)</td> </tr> <tr> <td>C 7 (7)</td> </tr> </table>	Main circuit	Terminal screw	M5	Terminal dimensions	A 13 (13)	B 6.5 (10)	C 7 (7)
				Main circuit		Terminal screw	M5				
Terminal dimensions	A 13 (13)										
	B 6.5 (10)										
	C 7 (7)										
<table border="1"> <tr> <td rowspan="3">Operating circuit</td> <td>Terminal screw</td> <td>M3.5</td> </tr> <tr> <td rowspan="3">Terminal dimensions</td> <td>A 7.8</td> </tr> <tr> <td>B 4</td> </tr> <tr> <td>C 4.5</td> </tr> </table>	Operating circuit	Terminal screw	M3.5	Terminal dimensions	A 7.8	B 4	C 4.5				
Operating circuit		Terminal screw	M3.5								
		Terminal dimensions	A 7.8								
	B 4										
C 4.5											
 <p><b>TR80B-1E</b> <b>TR80B-2E</b> <b>TR80B-1EF</b> <b>TR80B-2EF</b></p>	 <p>(0.36kg)</p>	 <p>3 M4 mounting holes</p>		<table border="1"> <tr> <td rowspan="3">Main circuit</td> <td>Terminal screw</td> <td>M6</td> </tr> <tr> <td rowspan="3">Terminal dimensions</td> <td>A 16.5 (16.5)</td> </tr> <tr> <td>B 8.5 (10.5)</td> </tr> <tr> <td>C 8 (9)</td> </tr> </table>	Main circuit	Terminal screw	M6	Terminal dimensions	A 16.5 (16.5)	B 8.5 (10.5)	C 8 (9)
				Main circuit		Terminal screw	M6				
Terminal dimensions	A 16.5 (16.5)										
	B 8.5 (10.5)										
	C 8 (9)										
<table border="1"> <tr> <td rowspan="3">Operating circuit</td> <td>Terminal screw</td> <td>M3.5</td> </tr> <tr> <td rowspan="3">Terminal dimensions</td> <td>A 7.8</td> </tr> <tr> <td>B 4</td> </tr> <tr> <td>C 4.5</td> </tr> </table>	Operating circuit	Terminal screw	M3.5	Terminal dimensions	A 7.8	B 4	C 4.5				
Operating circuit		Terminal screw	M3.5								
		Terminal dimensions	A 7.8								
	B 4										
C 4.5											

### TERMINAL SECTION DIMENSIONS

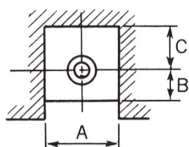
Values shown in parenthesis in the main circuit terminal dimensions are values of the power side.



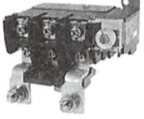
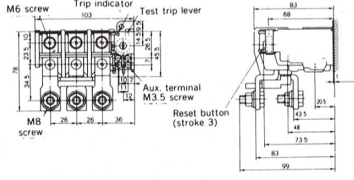
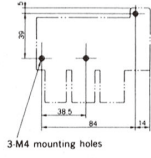
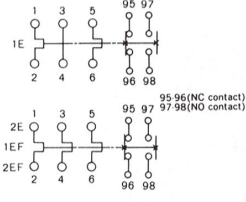

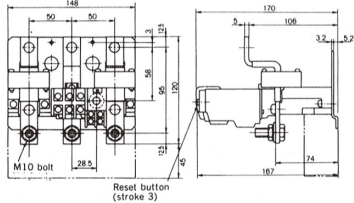
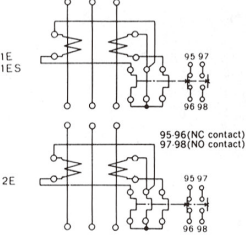
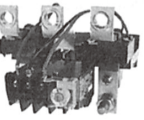
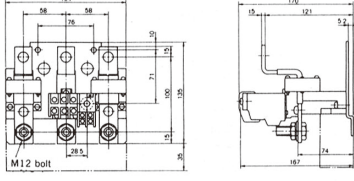
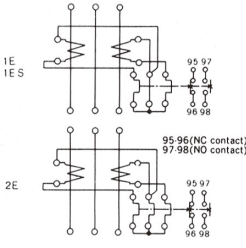
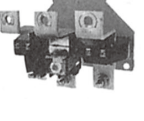
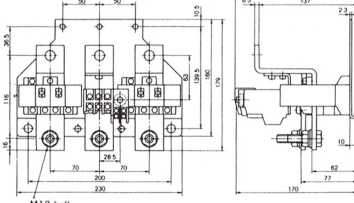
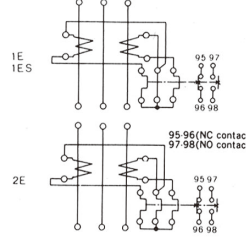
Appearance	Dimensions (mm) (Product mass)	Drilling plan	Contact arrangement	Terminal section dimensions (mm)										
 <p><b>TR150B-1E</b> <b>TR150B-2E</b> <b>TR150B-1EF</b> <b>TR150B-2EF</b></p>	 <p>(0.37kg)</p>			<table border="1"> <tr> <td rowspan="3">Main circuit</td> <td>Terminal screw</td> <td>M8 (M6)</td> </tr> <tr> <td rowspan="3">TR150B-2E</td> <td>A</td> <td>22 (16.5)</td> </tr> <tr> <td>B</td> <td>8 (10.5)</td> </tr> <tr> <td>C</td> <td>11 (9)</td> </tr> </table>	Main circuit	Terminal screw	M8 (M6)	TR150B-2E	A	22 (16.5)	B	8 (10.5)	C	11 (9)
				Main circuit		Terminal screw	M8 (M6)							
TR150B-2E	A	22 (16.5)												
	B	8 (10.5)												
	C	11 (9)												
<table border="1"> <tr> <td rowspan="3">Operating circuit</td> <td>Terminal screw</td> <td>M3.5</td> </tr> <tr> <td rowspan="3">Terminal dimensions</td> <td>A</td> <td>7.8</td> </tr> <tr> <td>B</td> <td>4</td> </tr> <tr> <td>C</td> <td>4.5</td> </tr> </table>	Operating circuit	Terminal screw	M3.5	Terminal dimensions	A	7.8	B	4	C	4.5				
Operating circuit		Terminal screw	M3.5											
		Terminal dimensions	A		7.8									
	B		4											
C	4.5													
 <p><b>TR250B-1E</b> <b>TR250B-2E</b> <b>TR250B-1ES</b></p>	 <p>(2.0kg)</p>	<p>For mounting to H200, H250</p>		<table border="1"> <tr> <td rowspan="3">Main circuit</td> <td>Terminal screw</td> <td>M10 bolt</td> </tr> <tr> <td rowspan="3">Terminal dimensions</td> <td>A</td> <td>37</td> </tr> <tr> <td>B</td> <td>12.5</td> </tr> <tr> <td>C</td> <td>16</td> </tr> </table>	Main circuit	Terminal screw	M10 bolt	Terminal dimensions	A	37	B	12.5	C	16
				Main circuit		Terminal screw	M10 bolt							
Terminal dimensions	A	37												
	B	12.5												
	C	16												
<table border="1"> <tr> <td rowspan="3">Operating circuit</td> <td>Terminal screw</td> <td>M3.5</td> </tr> <tr> <td rowspan="3">Terminal dimensions</td> <td>A</td> <td>7.8</td> </tr> <tr> <td>B</td> <td>4</td> </tr> <tr> <td>C</td> <td>4.5</td> </tr> </table>	Operating circuit	Terminal screw	M3.5	Terminal dimensions	A	7.8	B	4	C	4.5				
Operating circuit		Terminal screw	M3.5											
		Terminal dimensions	A		7.8									
	B		4											
C	4.5													
 <p><b>TR400B-1E</b> <b>TR400B-2E</b> <b>TR400B-1ES</b></p>	 <p>(2.0kg)</p>	<p>For mounting to H300, H400</p>		<table border="1"> <tr> <td rowspan="3">Main circuit</td> <td>Terminal screw</td> <td>M12 bolt</td> </tr> <tr> <td rowspan="3">Terminal dimensions</td> <td>A</td> <td>44</td> </tr> <tr> <td>B</td> <td>15</td> </tr> <tr> <td>C</td> <td>20</td> </tr> </table>	Main circuit	Terminal screw	M12 bolt	Terminal dimensions	A	44	B	15	C	20
				Main circuit		Terminal screw	M12 bolt							
Terminal dimensions	A	44												
	B	15												
	C	20												
<table border="1"> <tr> <td rowspan="3">Operating circuit</td> <td>Terminal screw</td> <td>M3.5</td> </tr> <tr> <td rowspan="3">Terminal dimensions</td> <td>A</td> <td>7.8</td> </tr> <tr> <td>B</td> <td>4</td> </tr> <tr> <td>C</td> <td>4.5</td> </tr> </table>	Operating circuit	Terminal screw	M3.5	Terminal dimensions	A	7.8	B	4	C	4.5				
Operating circuit		Terminal screw	M3.5											
		Terminal dimensions	A		7.8									
	B		4											
C	4.5													
 <p><b>TR600B-1E</b> <b>TR600B-2E</b> <b>TR600B-1ES</b></p>	 <p>(5.0kg)</p>			<table border="1"> <tr> <td rowspan="3">Main circuit</td> <td>Terminal screw</td> <td>M12 bolt</td> </tr> <tr> <td rowspan="3">Terminal dimensions</td> <td>A</td> <td>55</td> </tr> <tr> <td>B</td> <td>16</td> </tr> <tr> <td>C</td> <td>28</td> </tr> </table>	Main circuit	Terminal screw	M12 bolt	Terminal dimensions	A	55	B	16	C	28
				Main circuit		Terminal screw	M12 bolt							
Terminal dimensions	A	55												
	B	16												
	C	28												
<table border="1"> <tr> <td rowspan="3">Operating circuit</td> <td>Terminal screw</td> <td>M3.5</td> </tr> <tr> <td rowspan="3">Terminal dimensions</td> <td>A</td> <td>7.8</td> </tr> <tr> <td>B</td> <td>4</td> </tr> <tr> <td>C</td> <td>4.5</td> </tr> </table>	Operating circuit	Terminal screw	M3.5	Terminal dimensions	A	7.8	B	4	C	4.5				
Operating circuit		Terminal screw	M3.5											
		Terminal dimensions	A		7.8									
	B		4											
C	4.5													

Notes:

1) Changing Reset Method

Normally, relay is set in manual reset.

The change to automatic reset is done easily as shown in the following diagram.

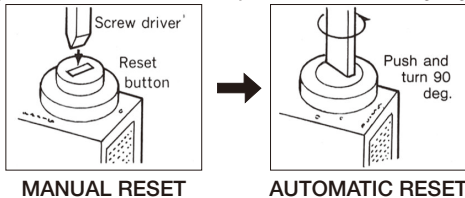

2) Opening Cover for Current Adjusting Knob

Turn protection cover by pulling up the projection with a finger.

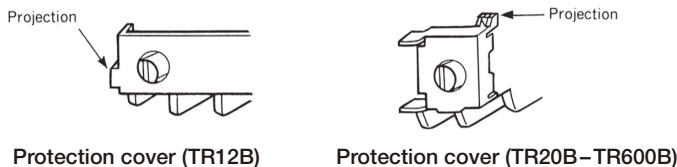

## 7. ELECTROMAGNETIC SWITCHES WITH 2E THERMAL OVERLOAD RELAY (OVERLOAD AND PHASE-FAILURE PROTECTION)

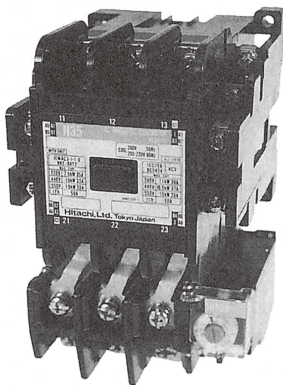

**B) H35-TK**  
**HS35-TK?**

The 2E thermal overload relay has the following features in comparison to the conventional semiconductor type 2E relay.

### <Features>

1. The size has been drastically reduced so that the mounting area is only about 40% and the weight about 30% of the conventional 2E relay.
2. Price has also been drastically reduced to about 40%.
3. Mounting and wiring have been facilitated.

### ELECTROMAGNETIC CONTACTOR

The electromagnetic contactor which has high efficiency and long life is used.

### 2E THERMAL OVERLOAD RELAY

With this design, a sensitive phase-failure protection function has been added to the 3-element thermal overload relay. It is the smallest thermal overload relay available. Besides this, it possesses stabilized characteristics features and many merits such as independent installation capability, handling convenience, safety, etc.

## 7.1 Phase-Failure Protection Effect of 2E Thermal Overload Relays

In case of smaller capacity motors, 3-element thermal overload relay can protect the motor from burn-out due to phase-failure operation.

However, since motors above medium capacity have a tendency that due to the rotor construction, the temperature rises remarkably at time of phase-failure, 1E thermal overload relay cannot protect the motor.

Nevertheless, when the 2E thermal overload relay is used even in such a case, protection at time of phase-failure can be ensured as it will operate before the motor temperature becomes high, as shown in the table below, by the action of the built-in differential phase-failure detection mechanism (Please refer to page 31: the principle of the differential phase-failure detection mechanism.).

Operation	Thermal overload relay	Motor capacity (200V, kW)	Temperature rise of motor at thermal overload relay operation		
			0.5	1	1.5
Three-phase 	1E or 2E thermal overload relay	0.2-132	*The temperature rise at three-phase overload operation of each motor is made 1.		
Phase-failure 	1E thermal overload relay	0.75	[Bar chart showing temperature rise]		
		3.7	[Bar chart showing temperature rise]		
		11	[Bar chart showing temperature rise]		
		55	[Bar chart showing temperature rise]		
		132	[Bar chart showing temperature rise]		
	1E thermal overload relay	0.75	[Bar chart showing temperature rise]		
		3.7	[Bar chart showing temperature rise]		
		11	[Bar chart showing temperature rise]		
		55	[Bar chart showing temperature rise]		
		132	[Bar chart showing temperature rise]		

The 2E thermal overload relay operates before the motor temperature becomes high.

## 7.2 Appearance and Dimensions

Since dimensions are the same as the standard type electromagnetic switch (those without K at the end), see pages 26 to 28 for non-reversible type frames without enclosure and page

29 for reversible type frames without enclosure. Moreover see page 30 for frames with enclosure.

## 8. DC OPERATED ELECTROMAGNETIC CONTACTORS

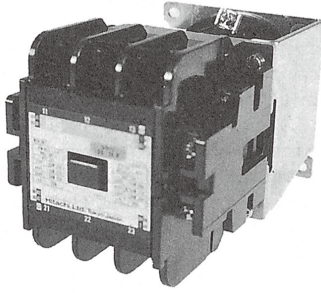

H35-G

### <Features>

1. The compact design drastically reduces the mounting space to the control panel.
2. DC exciting type is noiseless.
3. Direct input type without external resistors for models up to 65C frame.

### 8.1 Operating Principle of Double Coil

<p>H80C-G-H125C-G</p> <p>Remarks: C.C.: Closing coil H.C.: Holding coil</p>	<p>The double coil is a coil which has 2 coils, closing coil CC and holding coil HC are wound on the coil bobbin. In explaining the operation by the left diagram circuit, it becomes as below.</p> <p>(1) When BSa is closed, current flows as <math>(\oplus) \rightarrow BSS \rightarrow BSa \rightarrow 52NC \rightarrow CC \rightarrow (\ominus)</math> and only CC coil is excited and picked up.</p> <p>(2) When picked up, the changeover NC contact opens, and current flows as <math>(\oplus) \rightarrow BSS \rightarrow 52NO \rightarrow HC \rightarrow CC \rightarrow (\ominus)</math> and both coils of HC and CC are excited. After pick-up, the internal resistance of HC is large in comparison to that of CC so current decreases and watt loss of the coil is reduced.</p>	<p>H150C-G-H800C-G</p> <p>Change between closing coil (CC) and holding coil (HC) is controlled by the provided control circuit.</p>
---	--	---

### 8.2 Dimensions

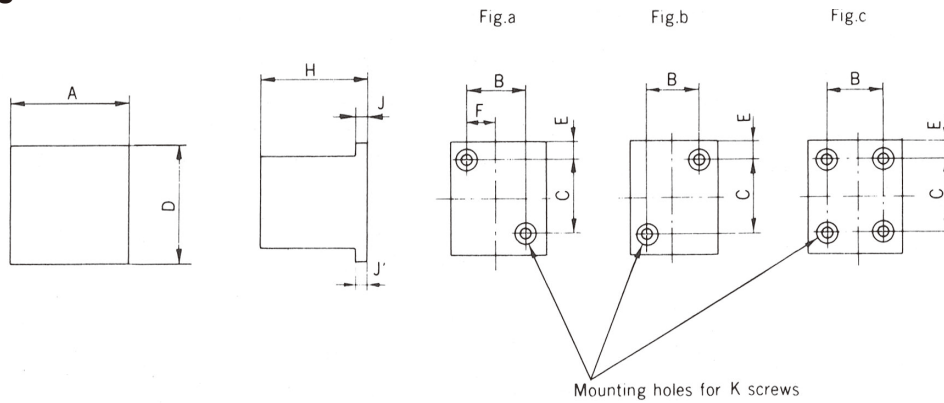

Model	Dimension (mm)				Drilling plan (mm)						Mass (kg)
	A	D	H	J (J')	Fig.	B	C	E	F	K	
H10-G	44	65	108	2.3	a	33	55	5	17	2-M4	0.5
H11-G	53	65	108	2.3	a	33	55	5	17	2-M4	0.58
H20-G	64	70	123	2.3	a	54	59	5.5	—	2-M4	1.02
H25-G	64	100	123	2.3	a	54	59	20.5	—	2-M4	1.08
H35-G H50-G	82	90	128.5	2.3	a	71	65	12.5	—	2-M4	1.7
H65C-G	88	106	147	2.3	a	71	65	20.5	—	2-M4	2.1
H80C-G H100C-G H125C-G	100 *(124)	136	154	17.5	b	84	110	13	—	2-M5	2.2
H150C-G	120 *(144)	153	165	17	b	100	130	11.5	—	2-M6	3.3
H200C-G H250C-G	138 *(162)	230	191	2.3	c	50	210	10	—	4-M8	5.5
H300C-G H400C-G	187 **(199)	240	225	3.2	c	60	220	10	—	4-M8	9.7
H600C-G	284	316	232	3.2	c	170	222	46	—	4-M10	22

Notes: \* Auxiliary contacts 4N03NC \*\* Auxiliary contacts 4N04NC

## 9. LATCHED ELECTROMAGNETIC CONTACTORS

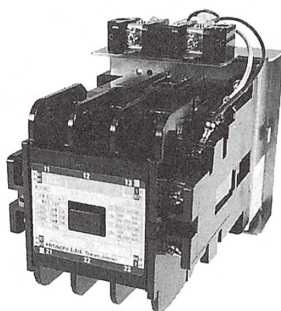

H35-TL

### <Features and Applications>

1. After the contact has been closed, the contactor has kept been in closed position mechanically, so that it cannot be released due to service interruption, momentary service interruption, voltage drop, etc. This contactor is most suitable such important circuits or memory circuits related to chemical plants, spinning machines, etc. which must be protected against its release particularly due to momentary service interruption or voltage drop.
2. Capable of being remote-controlled, and at ordinary times, free from power consumption of coil or humming. Ideal applications of the contactor are to distribution board circuits for facilities of buildings like hospitals, supermarkets, etc., automatic control circuits of street lights, motor load of display show-cases, etc. which are not often switched on and off or are continuously used for a long time.
3. In case of the reversible type, one with mechanical interlock can be manufactured. This is suitable for emergency power source changeover.
4. Self cut-off contact is equipped for both closing and tripping coils.
5. In an emergency, manual break is possible.

### 9.1 Explanation of Operation

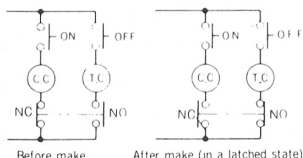

#### Explanation of Operation:

ON: Making by means of excitation of CC, which can be held mechanically. After making, the contact NO is in "ON" state, and the contact NC is in "OFF" state.  
 OFF: Releasing by means of excitation of TC. After release, the contact NO returns to "OFF", and the contact NC, to "ON". The contacts NO and NC are built in.

Notes: The ON and OFF contacts should be interlocked.

### 9.2 Dimensions

#### ■ Non-reversible type

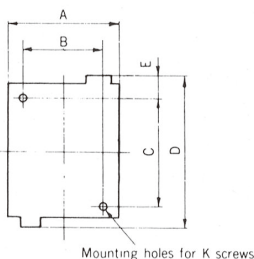

H10-L-H65C-L

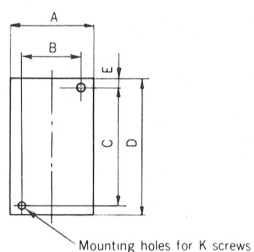

H80C-L-H150C-L

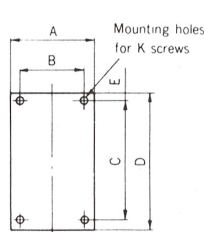

H200C-L-H600C-L

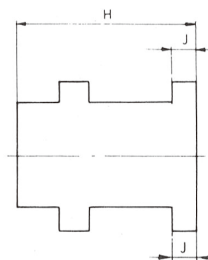

Model	Dimension (mm)								Mass (kg)
	A	B	C	D	E	H	J (J')	K	
H10-L	49	33	55	65	5	130	10	M4 X 2	0.4
H11-L	55	33	55	65	5	130	10	M4 X 2	0.42
H20-L	72	54	59	108 (122)	33.5 (47.5)	127	42	M4 X 2	0.85
H25-L	72	54	59	113 (127)	33.5 (47.5)	127	42	M4 X 2	0.9
H35-L	88	71	65	116 (130)	34.5 (48.5)	139	45	M4 X 2	1.2
H50-L	88	71	65	116 (130)	34.5 (48.5)	139	45	M4 X 2	1.2
H65C-L	91	70	65	127 (141)	34.5 (48.5)	145	44	M4 X 2	1.65
H80C-L	107	84	110	153 (154)	25.5 (26.5)	188	51	M5 X 2	2.7
H100C-L	107	84	110	153 (154)	25.5 (26.5)	188	51	M5 X 2	2.7
H125C-L	107	84	110	153 (154)	25.5 (26.5)	188	51	M5 X 2	2.7
H150C-L	134	100	130	194	43.5	201	53	M6 X 2	4.0
H200C-L	154	115	185	235	30	225	36	M8 X 4	8.0
H250C-L	154	115	185	235	30	225	36	M8 X 4	8.0
H300C-L	170	60	320	340	10	227	5.5	M8 X 4	11.7
H400C-L	170	60	320	340	10	227	5.5	M8 X 4	11.7
H600C-L	270	170	322	389	46	235	7.7 (5.5)	M10 X 4	28.0

Notes: ( ) DC operated Model H□□□-LG.

■ Reversible type

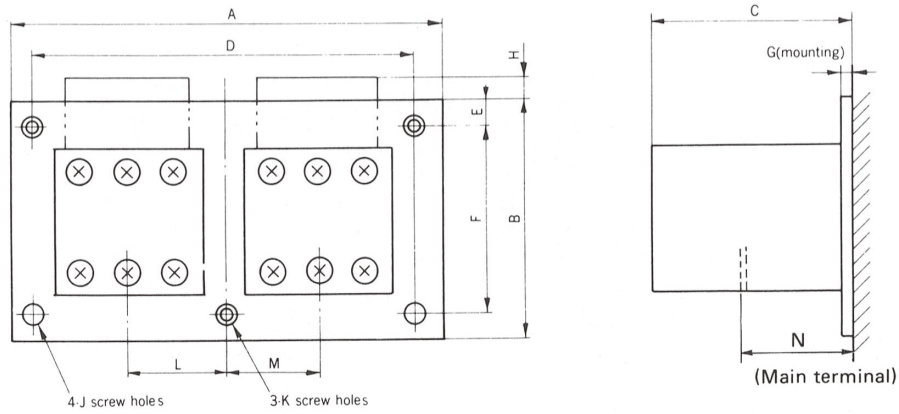

Model	Dimension (mm)													Mass (kg)
	A	B	C	D	E	F	G	H	J	K	L	M	N	
H11-RL	120	90	135	90	7.5	75	1.2	—	M4	—	31	33	71	1.0
H20-RL	172	110	133	155	5	100	1.6	— (13.5)	M4	—	41	41	95	2.0
H25-RL	172	110	133	155	5	100	1.6	— (13.5)	M4	—	41	41	*96, 76	2.1
H35-RL H50-RL	200	120	144	185	7.5	105	1.6	2 (16)	M5	—	53.5	47.5	106	2.7
H65C-RL	200	120	151	185	7.5	105	1.6	2 (16)	M5	—	53.5	53.5	107	3.6
H80C-RL H100C-RL H125C-RL	240	170	194	220	10	150	1.6	—	—	M6	59.5	59.5	125	6.1
H150C-RL	280	226	207	260	10	206	2.3	—	—	M6	76.5	62.5	139	10
H200C-RL H250C-RL	330	290	232	300	15	620	3.2	—	—	M8	78.5	78.5	143	19
H300C-RL H400C-RL	360	380	251	320	10	360	9.2	—	M8	—	94	94	147	26
H600C-RL	540	413	258	480	18	378	25	—	M10	—	135	135	163	67

- Notes:  
 1) ( ) DC operated Model H□□□-RLG.  
 2) \*96 R, T, U, W phase  
 76 S, V phase



## 10. AUTOMATIC STAR-DELTA STARTERS (3-CONTACTORS TYPE)

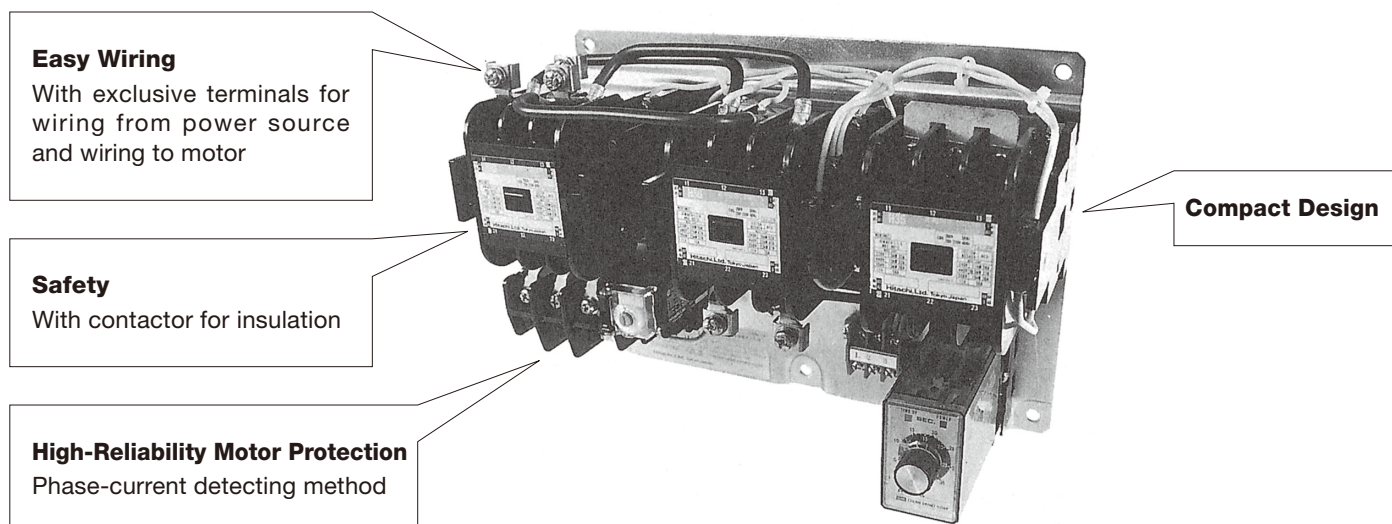

### 10.1 Ratings and Specifications

Voltage	Frame	Model		Motor capacity (AC3) (kW)	Components				
		Without enclosure	With enclosure		Contactor		Thermal overload relay		
					Insulation operation	Starting	Model	RC (A)	Adjustable range
200–220V	5	Y-5	SY-5	5.5	H20	H20	TR20B-2E	15	12–18
	7	Y-7	SY-7	7.5	H25	H20	TR20B-2E	15	12–18
	11	Y-11	SY-11	11	H35	H20	TR50B-2E	28	22–34
	15	Y-15	SY-15	15	H50	H25	TR50B-2E	28	22–34
	19	Y-19	SY-19	18.5	H50	H35	TR50B-2E	40	32–48
	22	Y-22	SY-22	22	H65C	H35	TR80B-2E	55	45–65
	30	Y-30	SY-30	30	H80C	H50	TR80B-2E	67	55–80
	37	Y-37	SY-37	37	H100C	H65C	TR150B-2E	80	65–95
	45	Y-45	SY-45	45	H125C	H65C	TR150B-2E	80	65–95
	55	Y-55	SY-55	55	H150C	H80C	TR150B-2E	105	90–120
	75	Y-75	SY-75	75	H200C	H125C	TR250B-2E	1.4 (140)	(110–170)
380–440V	11	Y4-11	SY4-11	11	H20	H20	TR20B-2E	9	7–11
	15	Y4-15	SY4-15	15	H25	H20	TR20B-2E	15	12–18
	19	Y4-19	SY4-19	18.5	H35	H25	TR50B-2E	20	16–24
	22	Y4-22	SY4-22	22	H50	H35	TR50B-2E	20	16–24
	30	Y4-30	SY4-30	30	H50	H35	TR50B-2E	28	22–34
	37	Y4-37	SY4-37	37	H65C	H50	TR80B-2E	40	32–48
	45	Y4-45	SY4-45	45	H65C	H65C	TR80B-2E	40	32–48
	55	Y4-55	SY4-55	55	H80C	H65C	TR80B-2E	55	45–65
	75	Y4-75	SY4-75	75	H100C	H80C	TR150B-2E	80	65–95
	90	Y4-90	SY4-90	90	H125C	H100C	TR150B-2E	80	65–95
	110	Y4-110	SY4-110	110	H150C	H125C	TR150B-2E	105	90–120

Notes:

- 1) Set thermal overload relay to the figure – rated current of motor x 0.58 – before operation.
- 2) Timer is set at 10 seconds, do not set at more than 15 seconds to prevent mal-operation of thermal overload relay at starting.
- 3) 400V 級スターデルタ始動器を操作電圧 400V で使用する場合、押しボタンスイッチを用いた自己保持回路としてください。シーケンサ等による自動運転の場合は、操作回路電圧を 200V、または 100V へ変更してください。

## 10.2 Connection Diagram

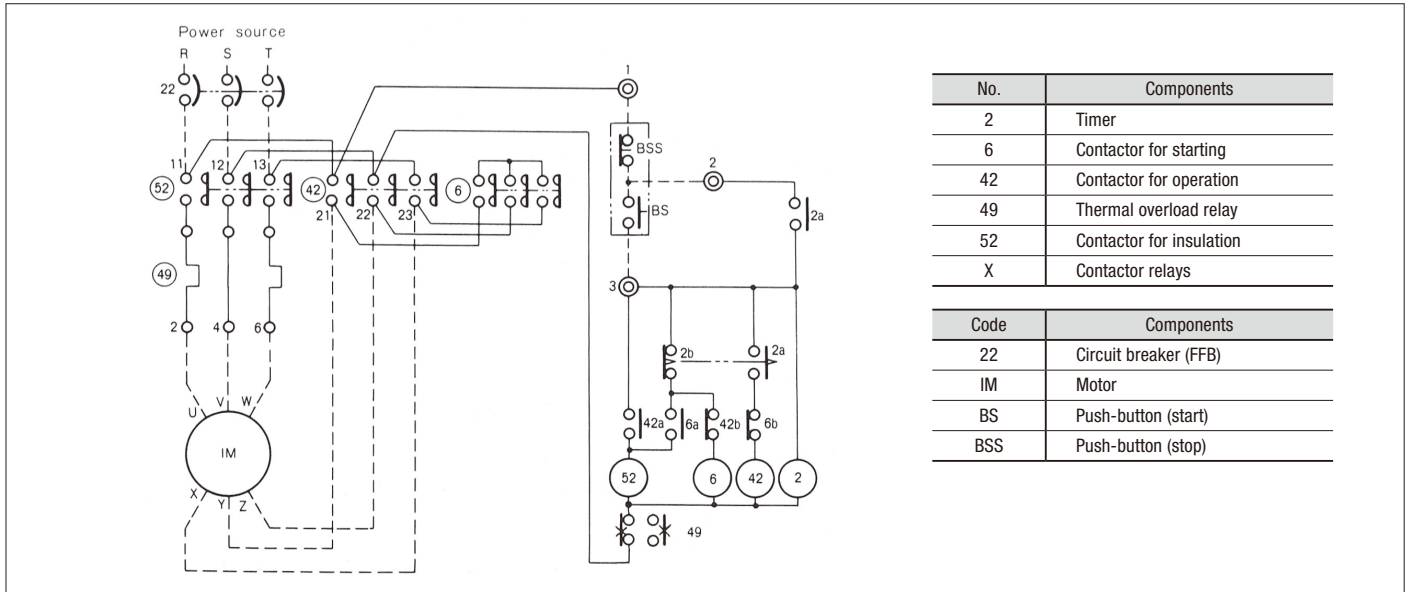

## 10.3 Dimensions

### (1) Without enclosure

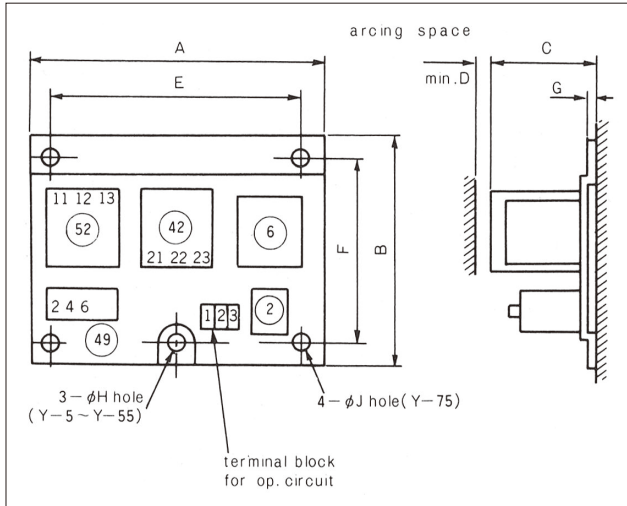

( ) In case of switch of 380–440V

Frame	220–240V	380–440V	Dimensions (mm)				Drilling plan (mm)					Mass (kg)
			A	B	C	D	E	F	G	H	J	
5.5	11	240	181	102	0	220	150	1.6	7	—	2.5 (3.8)	
7.5	15	280	200 (235)	114 (112)	0	260	180	200 (235)	7	—	4.2 (5.2)	
11	18.5			123 (122)							1	5.5 (6.5)
15	22	330	290	161 (124)	1	300	260	290	9	—	4.5 (5.4)	
18.5	30			161							1	5.5 (6.5)
22	37	370	300	161	1	340	270	300	9	—	8.5 (10)	
30	45										161	1
37	55	460	380	198	1	430	350	380	—	9	11 (12.5)	
45	75										172	1
—	90	—	—	—	—	—	—	—	—	—	22	
55	110	—	—	—	—	—	—	—	—	—	—	
75	—	—	—	—	—	—	—	—	—	—	—	

### (2) With enclosure

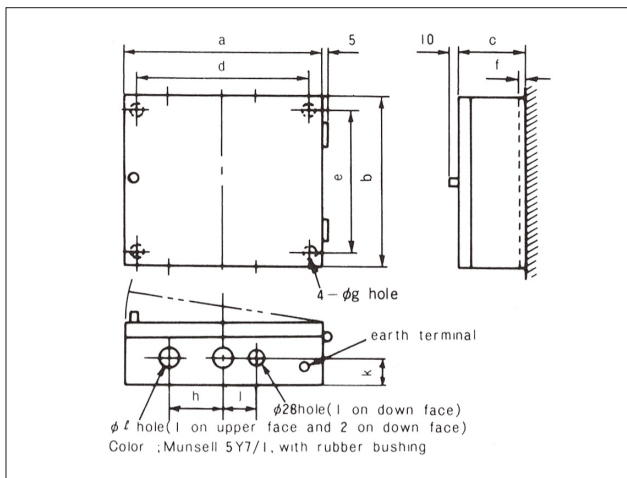

Frame	220–240V	380–440V	Dimensions (mm)				Drilling plan (mm)						Mass (kg)
			a	b	c	d	e	f	g	h	j	k	
5.5	11	270	270	150	200	230	1.6	6	80	40	70	28	6.8 (8.1)
7.5	15	320	320	150	250	250	1.6	7	100	60	80	42	9.7 (10.7)
11	18.5												10 (10.9)
15	22	370	400	180	300	350	1.6	9	100	70	90	42	11 (12)
18.5	30												16.3 (17.8)
22	37	420	500	190	350	400	1.6	9	120	90	100	64	16.8 (18.3)
30	45												21.5 (23.0)
37	55	520	570	230	400	450	1.6	9	170	100	100	64	22.5 (24.0)
45	75												22.5 (24.0)
—	90	—	—	—	—	—	—	—	—	—	—	—	36.5
55	110	—	—	—	—	—	—	—	—	—	—	—	—
75	—	—	—	—	—	—	—	—	—	—	—	—	—

Notes: In case of switch with enclosure, with push-buttons and/or pilot lights can be supplied on request.

# 11. CONTACTOR RELAYS



XS4

<Features>

**1. Self-Up Screw**

All models employ Hitachi's exclusive "self-up" screws with a seat for easy wiring.

**2. High Reliability**

The moving parts are made of thermoplastic resin to minimize wear. The rolling contacts of pure silver assure high contact reliability.

## 11.1 Application for the International Standards

Rated insulation voltage (V)	IEC 60947-4-1	NEMA	BS	VDE	UL	CSA
150	All Frames	All Frames	All Frames	All Frames	認定が必要です。	
250						
300						
380						
500						
600						
660, 690						

## 11.2 Coil Ratings

■ Standard type (AC operation)

Designation	Rated operational voltage	Color of coil outer wrapping	Terminal code
AC100V	100V 50Hz/100 – 110V 60Hz	Yellow	
AC200V	200V 50Hz/200 – 220V 60Hz	White	
AC400V	400V 50Hz/400 – 440V 60Hz	Red	
AC100V	Can be made within the range of 24V – 550V of other than those above.	Blue	

Notes: The latch's pick-up and tripping coil is of 30 seconds rating for both AC operation and DC operation.

■ DC operation

Designation and rated operational voltages

DC 24V, 48V, 100V, 110V, 200V, 220V

## 11.3 Contact Arrangement Diagram

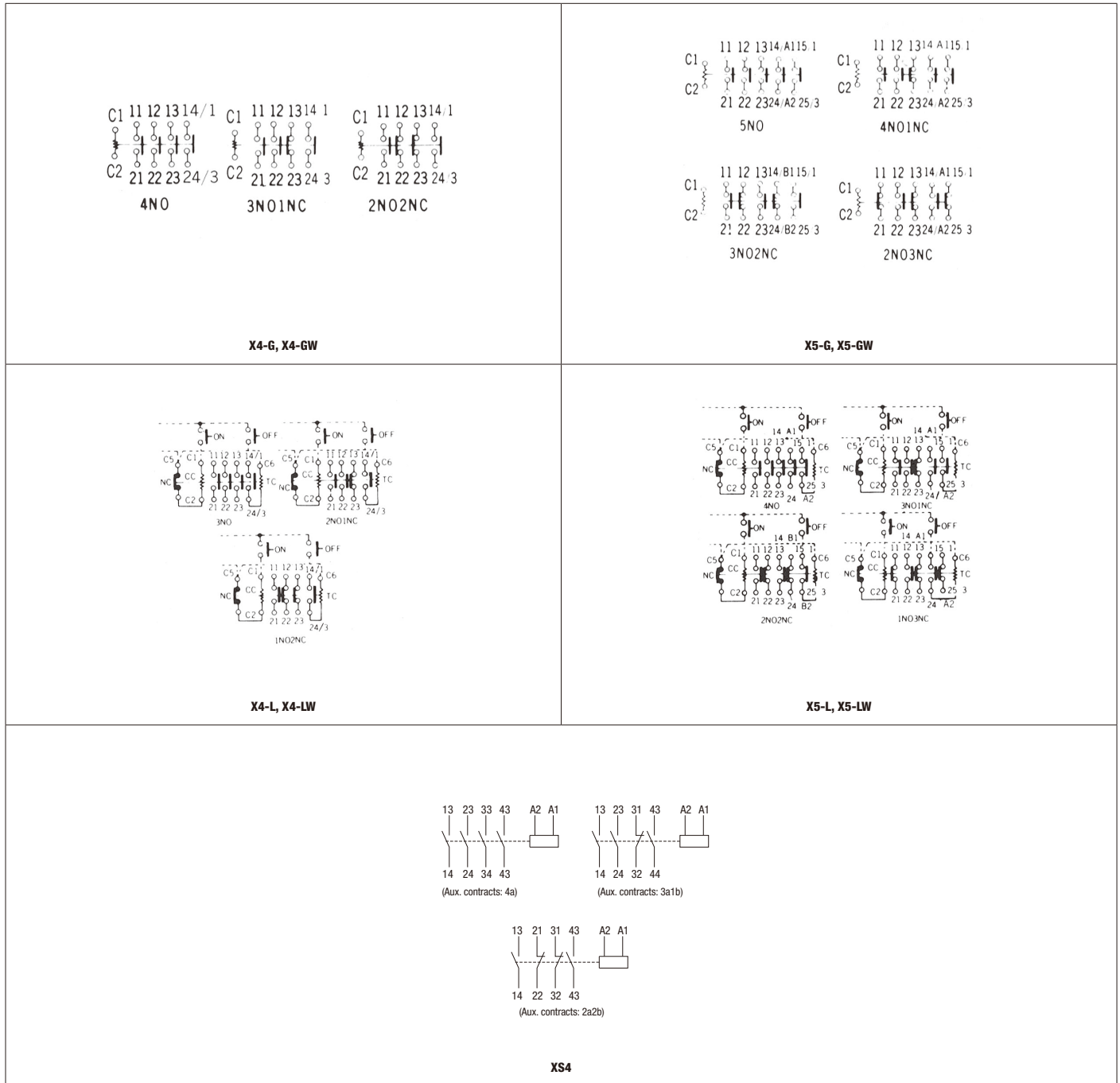

## 11.4 Dimensions and Mass

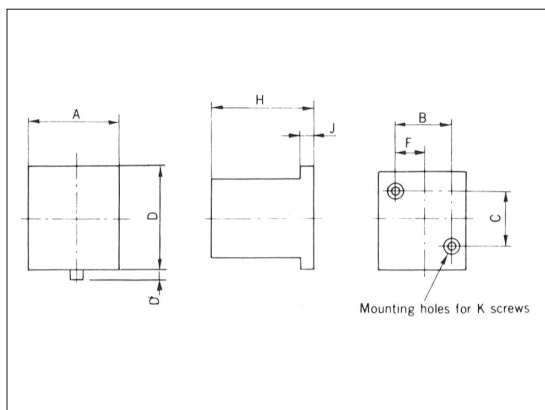

Model	Dimension (mm)				Drilling plan (mm)				Mass (kg)
	A	D (D')	H	J	B	C	F	K	
X4G, X4-GW	44	65	107	2.3	33	55	17	2-M4	0.54
X5G, X5-GW	53	65	108	2.3	33	55	17	2-M4	0.57
X4-L, X4-LW	49	65	130	10	33	55	16.5	2-M4	0.4
X5-L, X5-LW	55	65	130	10	33	55	16.5	2-M4	0.42
XS4									

## 12. OPTIONS

### 12.1 Aux. Contact Block, Lamp Unit, Safety Cover and Mechanical Interlock Unit

HS series					
Item	Model	Configuration	Rating	Applicable model	Mounting
Auxiliary contact block	SXS-2	Contact configuration 1a1b	Rated operational voltage (AC15) 220V 3A 440V 1.5A Open thermoelectric current (Ith) 10A	XS4 HS8-50	Refer to installation manual
	SXH-2	Contact configuration 2a 1a1b 2b			
	SXH-4	Contact configuration 4a 3a1b 2a2b			
Coil surge absorber	CS-50	—	AC 250V 抑制サージ電圧 600V (ピーク値) 以下	XS4 HS8-50	ケース溝部にはめ込みます。 L=0mm
Safety cover	TCS-10, TCS-10T	TC type	—	XS4, 8,10 frame	Refer to installation manual
	TCS-20, TCS-20T		—	20 frame	
	TCS-25, TCS-25T		—	25 frame	
	TCS-50, TCS-50T		—	35, 50 frame	
	CVS-10	CV type	—	XS4, 8,10 frame (non-reversible)	
	CVS-25		—	20, 25 frame	
	CVS-50		—	35, 50 frame	
	CVS-10R		—	10 frame (reversible)	
	FPS-S2	FP type	—	SXS-2	
	FPS-H2		—	SXH-2	
FPS-H4	—		SXH-4		
Mechanical-Interlock unit	RI-50	—	—	10-50 (reversible)	Refer to installation manual

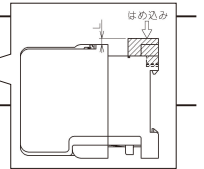

H series						
Item	Model	Configuration	Rating	Applicable model	Mounting	
Auxiliary contact block	AX-20	Contact configuration 1a1b	Rated operational voltage (AC15) 220V 2A 440V 1A 定格通電電流 10A	20, 25, 35, 50 frame	Notes: Cannot be applied to the DC operated contactor (H [ ] -G)	
	AX-65			65C frame		
	AX-80			80C, 100C, 125C, 150C, 200C, 250C, 300C, 400C frame		
Coil surge absorber	CS-8	—	AC 250V 抑制サージ電圧 600V (ピーク値) 以下	X3, X4, X5, X6, X8, 8C, 10C, 10B, 11, 12, 20, 25, 35, 50, 65C frame	ケース溝部にはめ込みます。 L=2-6mm	
	CS-80			80C, 100C, 125C frame		
コイル騒動ユニット	CX-20	—	—	20, 25, 35, 50 frame	in the same way as AX-20 (above)	
Safety cover	CV-8E	—	—	8C, 10C frame	Example of CV-8E カバーを湾曲させ矢印方向に差し込み本体の突起にはめ込みます。  電磁接触器のカバーにねじ止めします。専用タッピングねじが添付されています。  カバーの切欠きをサーマルリレー本体の突起に合わせて押し込みます。	
	CV-11E			11 frame		
	CV-20			20, 25 frame		
	CV-35			35, 50 frame		
	CV-65			65C frame		
	CV80, CV80T			80C, 100C, 125C frame		
	CV150, CV150T			150C frame		
	CV200, CV200T			200C, 250C frame		
	CV300, CV300T			300C, 400C frame		
	CV600, CV600T			600C, 800C frame		
	CV-T20B			Thermal overload relay 20B frame		飽和リアクタ付を除きます。
	CV-T50B			50B frame		
	CV-T80B			80B frame		
Reset release	RR-350	—	Dimension 350mm	Thermal overload relay 20B, 25B, 50B, 80B, 150B frame	リセットリリースのキャップをサーマルリレーの電流調整つまみにはめ込みます。	
	RR-500					Dimension 500mm
	RR-600					Dimension 600mm
Mechanical-Interlock unit	RI-20	—	—	Reversible type of 20, 25, 35 frame	電磁接触器の凹部にインターロックユニットの凸をはめ込み組立てます。ユニットに添付の取説に従って組立ててください。	
	RI-65	—	—	Reversible type of 65C frame		
サーマルリレー単独設置ユニット	ST-12B	—	—	Thermal overload relay 12B frame		



図8 (12-22, 13-23) 8極リレー (CV-8E)





## 12.2 Coil Surge Absorber

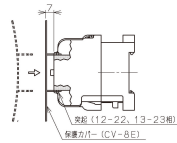
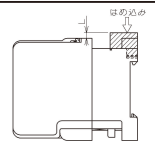
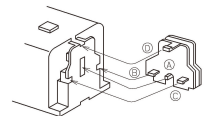
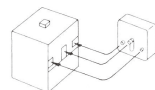

CS-8

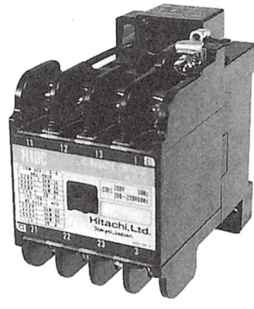

H10C with CS-8

### <Features>

1. High reliability
2. Easy mounting to contactors and switches.

Generally, in the semiconductor circuits, an external noise may cause an unexpected malfunction. When operating the contactor, the coil generates a sharp surge voltage with the result that the peak voltage may reach higher than 4kV and the frequency higher than 5kHz.

This is radiated as noise to the outside, and it is difficult to prevent such noise even if a protective element is placed in the semiconductor circuit. Therefore, it is necessary to take measures against occurrence of noise from the coil. Connect coil surge absorber to the coil of the contactor in parallel. Then, the noise generated from the coil can be reduced.

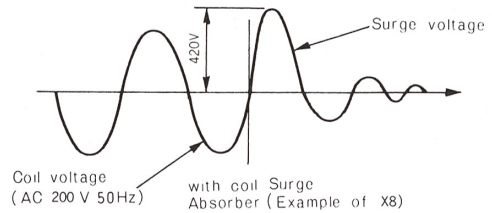
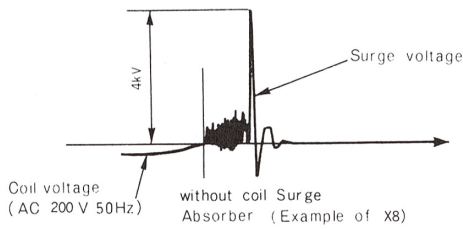

### ■ Ratings and Specifications

Model	Rated Voltage	Applicable models	Suppressed surge voltage (max.)
CS-50	AC250V	XS4, HS8-HS50	600V Peak
CS-8		X3, X4, X5, X6, X8 H8C, H10C, H10B-R, H11, H12, H20, H25, H35, H50, H65C	
CS-80		H80C, H100C, H125C	

### ■ Dimensions

#### CS-8, CS-80

( ) : CS-80 (10g)

#### EXAMPLE OF CONNECTION

Connect to the coil terminals of contactor

: Coil Surge Absorber

Model	Mounting	Dimensions
CS-50		No change in the size
CS-8 CS-80		$\ell = 2-6\text{mm}$

# 13. OLD PRODUCTS (BACKLOG)

## ■ Non-Reversible Electromagnetic Contactors without Enclosure

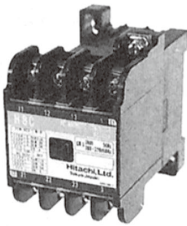
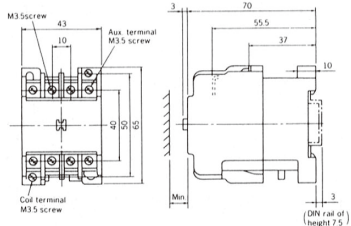
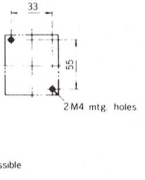
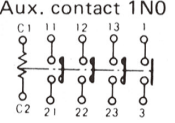
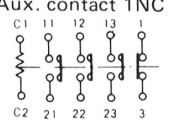
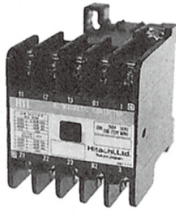
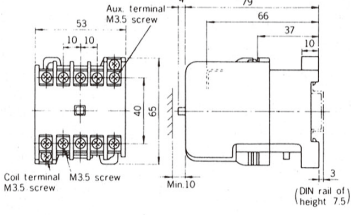
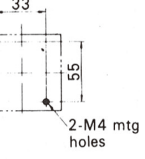
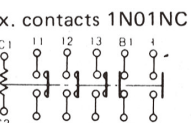
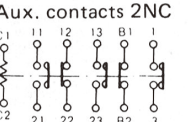
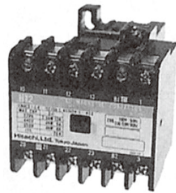
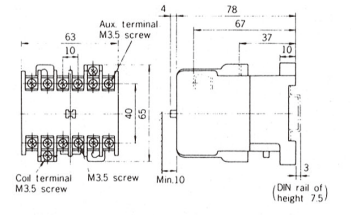
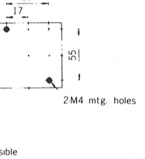
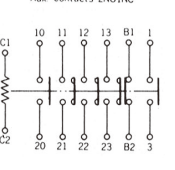
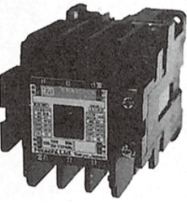
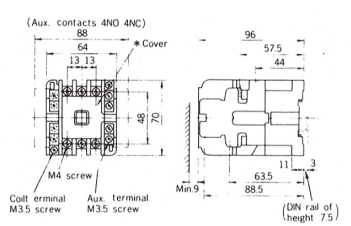
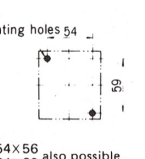
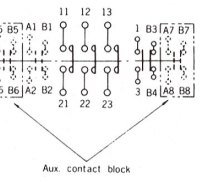
Appearance	Dimensions (mm) (Product mass)	Drilling plan	Contact arrangement	Terminal section dimensions (mm)						
 <p><b>H8C, H10C</b></p>	 <p>(0.25kg)</p>	 <p>2 M4 mtg. holes</p> <p>30 - 48 34 - 48 34 - 52 35 - 50 also possible</p>	<p>Aux. contact 1NO</p>  <p>Aux. contact 1NC</p> 	<p>Main circuit</p> <p>Terminal screw M3.5</p> <p>Terminal dimensions</p> <table border="1"> <tr><td>A</td><td>7,8</td></tr> <tr><td>B</td><td>5</td></tr> <tr><td>C</td><td>4,8</td></tr> </table>	A	7,8	B	5	C	4,8
				A	7,8					
B	5									
C	4,8									
<p>Operating circuit</p> <p>Terminal screw M3.5</p> <p>Terminal dimensions</p> <table border="1"> <tr><td>A</td><td>7,8</td></tr> <tr><td>B</td><td>5</td></tr> <tr><td>C</td><td>4,8</td></tr> </table>	A	7,8	B	5	C	4,8				
A	7,8									
B	5									
C	4,8									
 <p><b>H11</b></p>	 <p>(0.32kg)</p>	 <p>2-M4 mtg. holes</p> <p>30 - 48 34 - 48 34 - 52 35 - 50 also possible</p>	<p>Aux. contacts 1NO1NC</p>  <p>Aux. contacts 2NC</p> 	<p>Main circuit</p> <p>Terminal screw M3.5</p> <p>Terminal dimensions</p> <table border="1"> <tr><td>A</td><td>7,8</td></tr> <tr><td>B</td><td>5</td></tr> <tr><td>C</td><td>4,8</td></tr> </table>	A	7,8	B	5	C	4,8
				A	7,8					
B	5									
C	4,8									
<p>Operating circuit</p> <p>Terminal screw M3.5</p> <p>Terminal dimensions</p> <table border="1"> <tr><td>A</td><td>7,8</td></tr> <tr><td>B</td><td>5</td></tr> <tr><td>C</td><td>4,8</td></tr> </table>	A	7,8	B	5	C	4,8				
A	7,8									
B	5									
C	4,8									
 <p><b>H12</b></p>	 <p>(0.49kg)</p>	 <p>2M4 mtg. holes</p> <p>30 - 48 34 - 48 34 - 52 35 - 50 also possible</p>	<p>Aux. contacts 2NO1NC</p> 	<p>Main circuit</p> <p>Terminal screw M3.5</p> <p>Terminal dimensions</p> <table border="1"> <tr><td>A</td><td>7,8</td></tr> <tr><td>B</td><td>5</td></tr> <tr><td>C</td><td>4,8</td></tr> </table>	A	7,8	B	5	C	4,8
				A	7,8					
B	5									
C	4,8									
<p>Operating circuit</p> <p>Terminal screw M3.5</p> <p>Terminal dimensions</p> <table border="1"> <tr><td>A</td><td>7,8</td></tr> <tr><td>B</td><td>5</td></tr> <tr><td>C</td><td>4,8</td></tr> </table>	A	7,8	B	5	C	4,8				
A	7,8									
B	5									
C	4,8									
 <p><b>H20</b></p>	 <p>(0.49kg)</p>	<p>2-M4 mounting holes 54</p>  <p>54x56 54x60 also possible</p>	<p>Aux. contact block</p> 	<p>Main circuit</p> <p>Terminal screw M4</p> <p>Terminal dimensions</p> <table border="1"> <tr><td>A</td><td>9</td></tr> <tr><td>B</td><td>4,5</td></tr> <tr><td>C</td><td>5,5</td></tr> </table>	A	9	B	4,5	C	5,5
				A	9					
B	4,5									
C	5,5									
<p>Operating circuit</p> <p>Terminal screw M3.5</p> <p>Terminal dimensions</p> <table border="1"> <tr><td>A</td><td>7,8</td></tr> <tr><td>B</td><td>5,5</td></tr> <tr><td>C</td><td>4,8</td></tr> </table>	A	7,8	B	5,5	C	4,8				
A	7,8									
B	5,5									
C	4,8									

Model	Dimensions					Minimum mounting space (mm)				
	D	E	F	G	H	D	E	F	G	H
H8C, H10C	10	15	5	10	5	10	15	5	10	5
H11	10	15	5	10	5	10	15	5	10	5
H12	10	15	5	10	5	10	15	5	10	5
H20	9	15	5	10	5	9	15	5	10	5

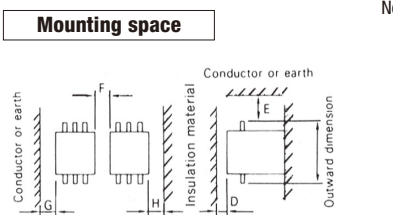

Note: Do not operate with the cover removed (Check by removing the cover only when inspecting the contact and always be sure to securely push in the cover after checking).

**Terminal section dimensions**

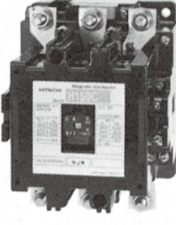
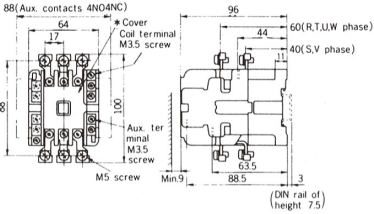
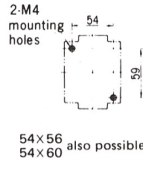
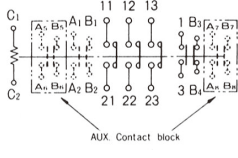
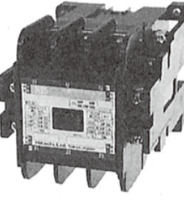
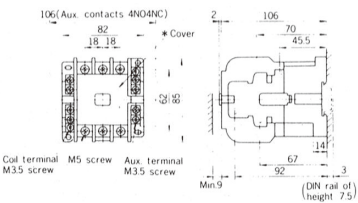
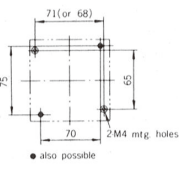
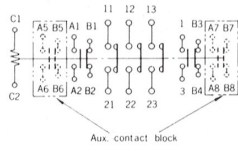
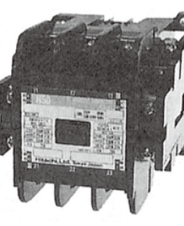
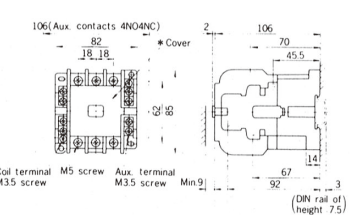
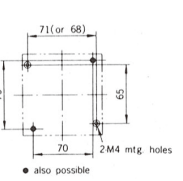
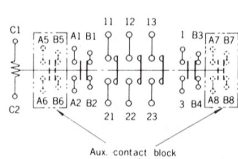

Appearance	Dimensions (mm) (Product mass)	Drilling plan	Contact arrangement	Terminal section dimensions (mm)		
 <p><b>H25</b></p>	 <p>88(Aux. contacts 4NO4NC) Cover Coil terminal M3.5 screw Aux. terminal M3.5 screw M5 screw Min 9 96 60(R.T.U.W phase) 40(S.V phase) 88.5 3 (DN rail of height 7.5)</p>	 <p>2-M4 mounting holes 54 50 54x56 54x60 also possible</p>	 <p>AUX. Contact block</p>	Main circuit	Terminal screw	M5
					Terminal dimensions	A
B	6					
Operating circuit	Terminal screw	M3.5				
	Terminal dimensions	A	7.8			
		B	5.5			
C	4.8					
 <p><b>H35</b></p>	 <p>106(Aux. contacts 4NO4NC) Cover Coil terminal M3.5 screw Aux. terminal M3.5 screw M5 screw Min 9 2 106 70 45.5 67 14 3 (DN rail of height 7.5)</p>	 <p>71(or 68) 75 65 70 2M4 mtg. holes • also possible</p>	 <p>Aux. contact block</p>	Main circuit	Terminal screw	M5
					Terminal dimensions	A
B	6					
Operating circuit	Terminal screw	M3.5				
	Terminal dimensions	A	7.8			
		B	5.5			
C	4.8					
 <p><b>H50</b></p>	 <p>106(Aux. contacts 4NO4NC) Cover Coil terminal M3.5 screw Aux. terminal M3.5 screw M5 screw Min 9 2 106 70 45.5 67 14 3 (DN rail of height 7.5)</p>	 <p>71(or 68) 75 65 70 2M4 mtg. holes • also possible</p>	 <p>Aux. contact block</p>	Main circuit	Terminal screw	M5
					Terminal dimensions	A
B	6					
Operating circuit	Terminal screw	M3.5				
	Terminal dimensions	A	7.8			
		B	5.5			
C	4.8					

Model	Dimensions					Minimum mounting space (mm)				
	D	E	F	G	H	D	E	F	G	H
H25	9	15	5	10	5	9	15	5	10	5
H35	9	15	5	10	5	9	15	5	10	5
H50	9	15	5	10	5	9	15	5	10	5

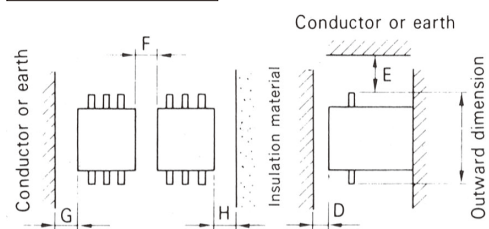

**Mounting space**

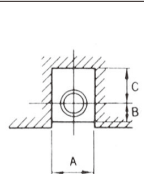

**Terminal section dimensions**

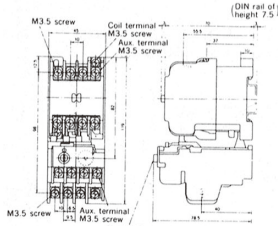
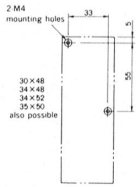
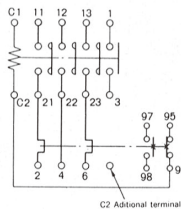

## ■ Non-Reversible Electromagnetic Switches without Enclosure

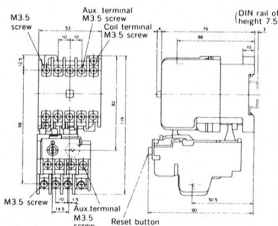
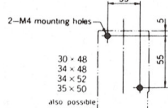
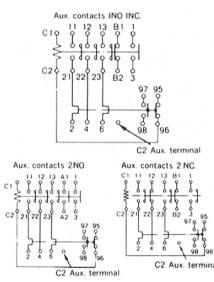
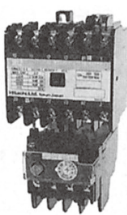
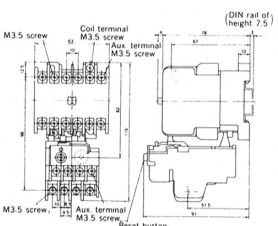
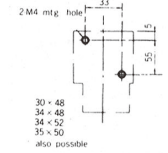
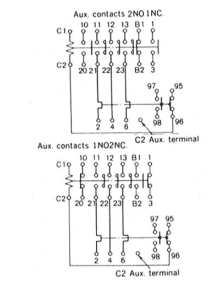
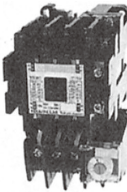
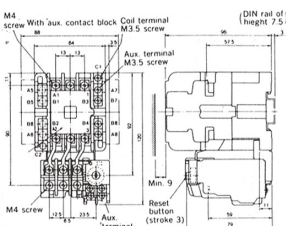
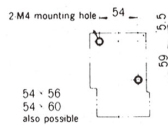
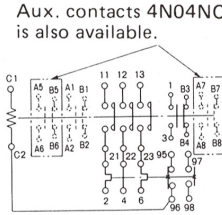
Appearance	Dimensions (mm) (Product mass)	Drilling plan	Contact arrangement	Terminal section dimensions (mm)			
				Electro-magnetic contactor	Thermal overload relay		
 <p><b>B) H8-T</b> <b>B) H10C-T</b></p>	 <p>(0.34kg)</p>			Main circuit	Terminal screw	M3.5	M3.5
					Terminal dimensions	A	7.8
B	5	6					
C	4.8	4.5					
Operating circuit	Terminal screw	M3.5	M3.5				
	Terminal dimensions	A	7.8	7.6			
		B	5	4			
C		4.8	4.5				
 <p><b>B) H11-T</b></p>	 <p>(0.41kg)</p>			Main circuit	Terminal screw	M3.5	M3.5
					Terminal dimensions	A	7.8
B	5.5	6					
C	4.8	4.5					
Operating circuit	Terminal screw	M3.5	M3.5				
	Terminal dimensions	A	7.8	7.6			
		B	5.5	4			
C		4.8	4.5				
 <p><b>B) H12-T</b></p>	 <p>(0.65kg)</p>			Main circuit	Terminal screw	M3.5	M3.5
					Terminal dimensions	A	7.8
B	5.5	6					
C	4.8	4.5					
Operating circuit	Terminal screw	M3.5	M3.5				
	Terminal dimensions	A	7.8	7.6			
		B	5.5	4			
C		4.8	4.5				
 <p><b>B) H20-T</b></p>	 <p>(0.65kg)</p>		 <p>Aux. contacts 4NO4NC is also available.</p>	Main circuit	Terminal screw	M4	M4
					Terminal dimensions	A	9
B	4.5	9					
C	5.5	5					
Operating circuit	Terminal screw	M3.5	M3.5				
	Terminal dimensions	A	7.8	7.8			
		B	5.5	4			
C		4.8	4.5				

Model	Dimensions					Minimum mounting space (mm)				
	D	E	F	G	H	D	E	F	G	H
B) H8-T B) H10C-T	10	15	5	10	5	10	15	5	10	5
B) H11-T	10	15	5	10	5	10	15	5	10	5
B) H12-T	10	15	5	10	5	10	15	5	10	5
B) H20-T	9	15	5	10	5	9	15	5	10	5

### Mounting space

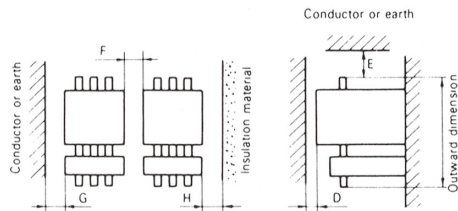

### Terminal section dimensions

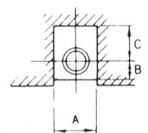



## 14. MAINTENANCE

### • Maintenance of Contacts

Contacts are sometimes subjected to blackening during usage due to oxide and sulfide films. However, use them as they are because they have absolutely no effect on the performance.

### • Maintenance of Coil

The allowable voltage regulation as specified in the standard is 85–110% of the rating.

When the voltage is too high, the impulse becomes great in case of closing and not only does it adversely affect each part but the coil becomes overheated and the coil life is shortened.

When the voltage is too low, a humming sound emanates from the magnet due to insufficient closing force of the magnet or a melting phenomenon occurs as the contacting force of the contactor weakens. Therefore, care should be taken that it is only used in the allowable voltage range.

### • Tightening of Screws

Since screws will become loosened over a long period of time due to vibrations, etc., be sure to check screws of each section about once a month. When used with the screw loose, the section will overheat and cause troubles.

### • Contact Surface of Electromagnet

It will become the cause of beats when dust accumulates or rust forms on the contact surface.

#### • When dust accumulates on the contact surface:

Clean the surface by wiping with a cloth.

#### • When rust forms on the contact surface:

Place sandpaper on a flat table and rub the rusted contact surface lightly and evenly on the sandpaper with the rusted surface facing downward.

### • Replacement Method of Contact

#### (Example 1) Case of H20

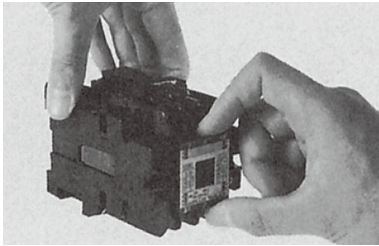

Remove the cover.

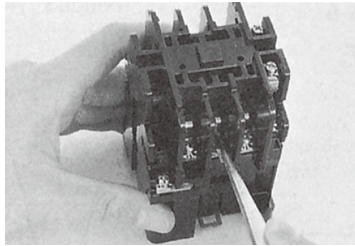

Pull out the moving contact with tweezers.

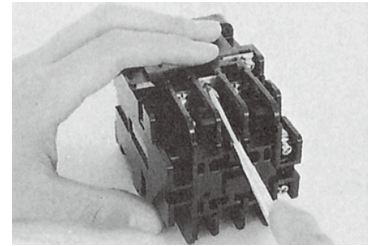

Replace the fixed contact with a screwdriver.

#### (Example 2) Case of H150C

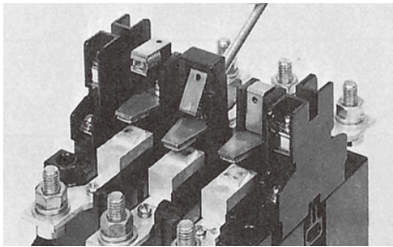

Remove the cover and turn the spring holder.

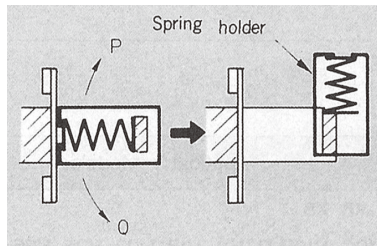

Turn the spring holder with fingers or a screwdriver by pushing to the P or O direction.

Notes: In reassembly, turn the spring holder completely back to its former position.

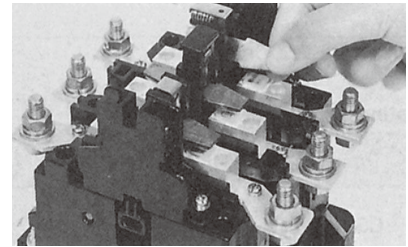

The moving contact can be removed when turned slightly. Remove the fixed contact with a screwdriver.

### • Replacement of Coil

#### (Example 1) Case of H20

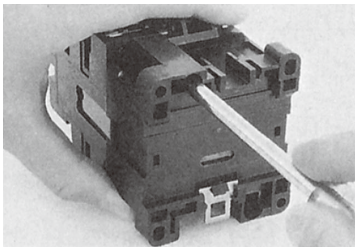

Remove case.

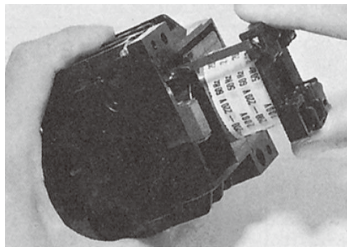

Remove the coil and replace with a new one.

#### (Example 2) Case of H150C

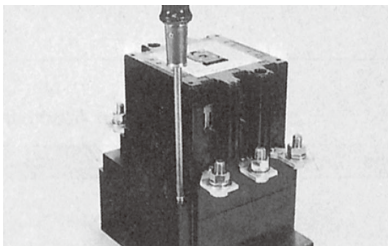

Ⓐ) Loose screws securing Insulating cover to case.

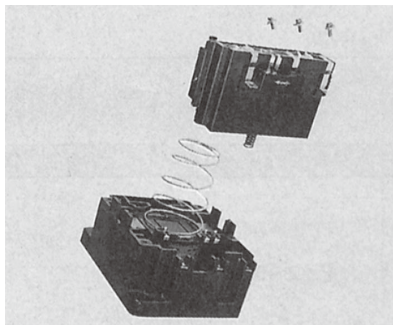

Ⓑ) After removing Insulating cover, loose 3 screws of coil terminals.

Ⓑ) Remove control unit and return spring.

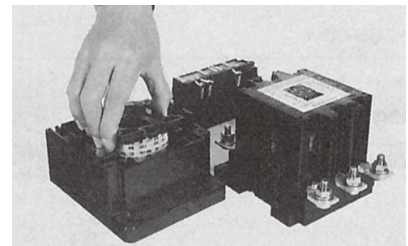

Ⓒ) Replace to prescribed coil.

Ⓒ) Reassemble in order Ⓑ-Ⓑ-Ⓐ)

Ⓒ) Control unit must be suit for replaced coil, and must be replaced with coil at the same time.

Ⓒ) Coil terminals for excepting 100/200V coil are Ⓒ-Ⓑ.

Ⓒ) Secure transparent dustproof covers on both sides.



**(Example 3) Case of H300C-H800C**

Coil and control unit must be changed at the same time.

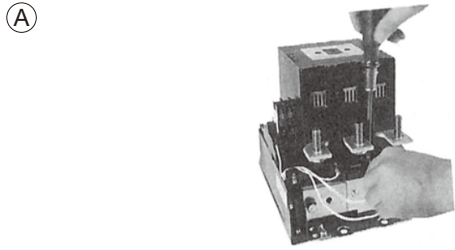

Remove the connecting wires (red, white, yellow) between coil and control unit.  
Remove the control unit.

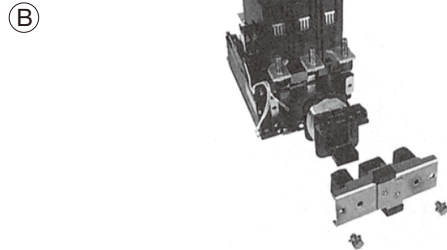

After loosening screws, remove the holding plate.  
Remove the coil and replace to prescribed coil.

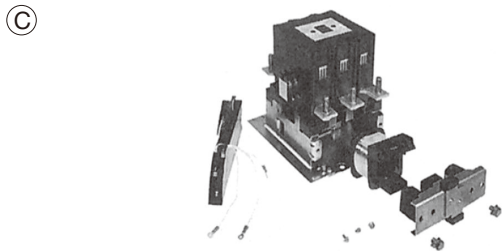

Replace the control unit which must be suit for the coil, at the same time of coil replacement.

Notes:  
In case of H600C-R and H800C-R (Reversible type), mount the control unit of the contactor for forward on the left side.

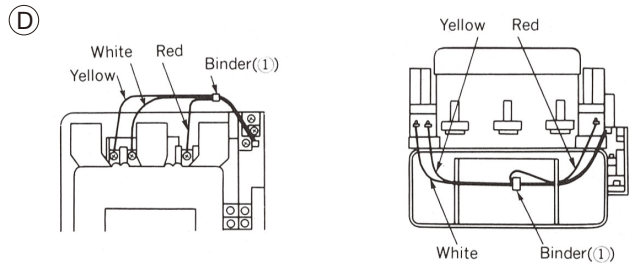
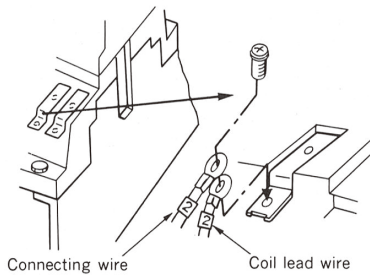

**H300C, H400**

**H600C, H800**

Reconnect the wires (red, white, yellow) between coil and control unit.

Notes: Bind the wires with the binder (1) packed with the control unit.

Notes:  
In case of H600C, H800C, connecting wires and coil lead wires have the numbers (1, 2, and 3) at the end of wires.  
Connect the wires of same number with the terminals.

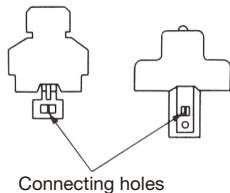
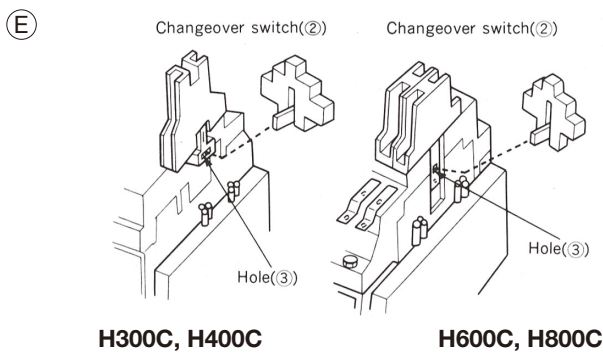

On mounting the changeover switch (2) on the control unit with screw, projection of movable portion on the changeover switch must be inserted to the hole of crossbar (3) for the auxiliary contact of contactor.

Caution: Insert the projection of the changeover switch to the correct hole of auxiliary contact unit

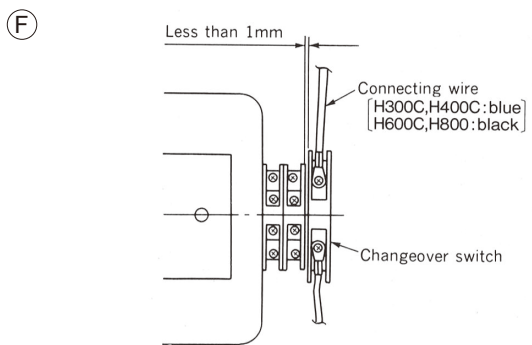

Connect the two blue wires (In case of H600C and H800C, black) with the terminals of changeover switch.

Notes:  
After reassembling, adjust position of the control unit to make distance between the top of the changeover switch with the auxiliary contact unit closer than 1mm.

- Notes:
- 1) The changeover switches of H600C and H800C differ from H300C and 400C's ones. (Their shapes are the same but parts in it are not the same.)
  - 2) There is the white mark on the case of H600C and H800C's changeover switch, but no mark on H300C and H400C's one.

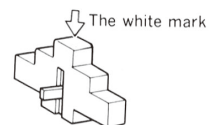

# K-TYPE MANUAL SWITCHES



SK2-TB

## <Features>

### 1. Small in Size and Light in Weight

Suitable as small-sized power switches for various kinds of industrial machines.

### 2. Easy Operation and Accurate Switching

#### ■ Note

These are switches without motor protection device.

## ■ Specifications





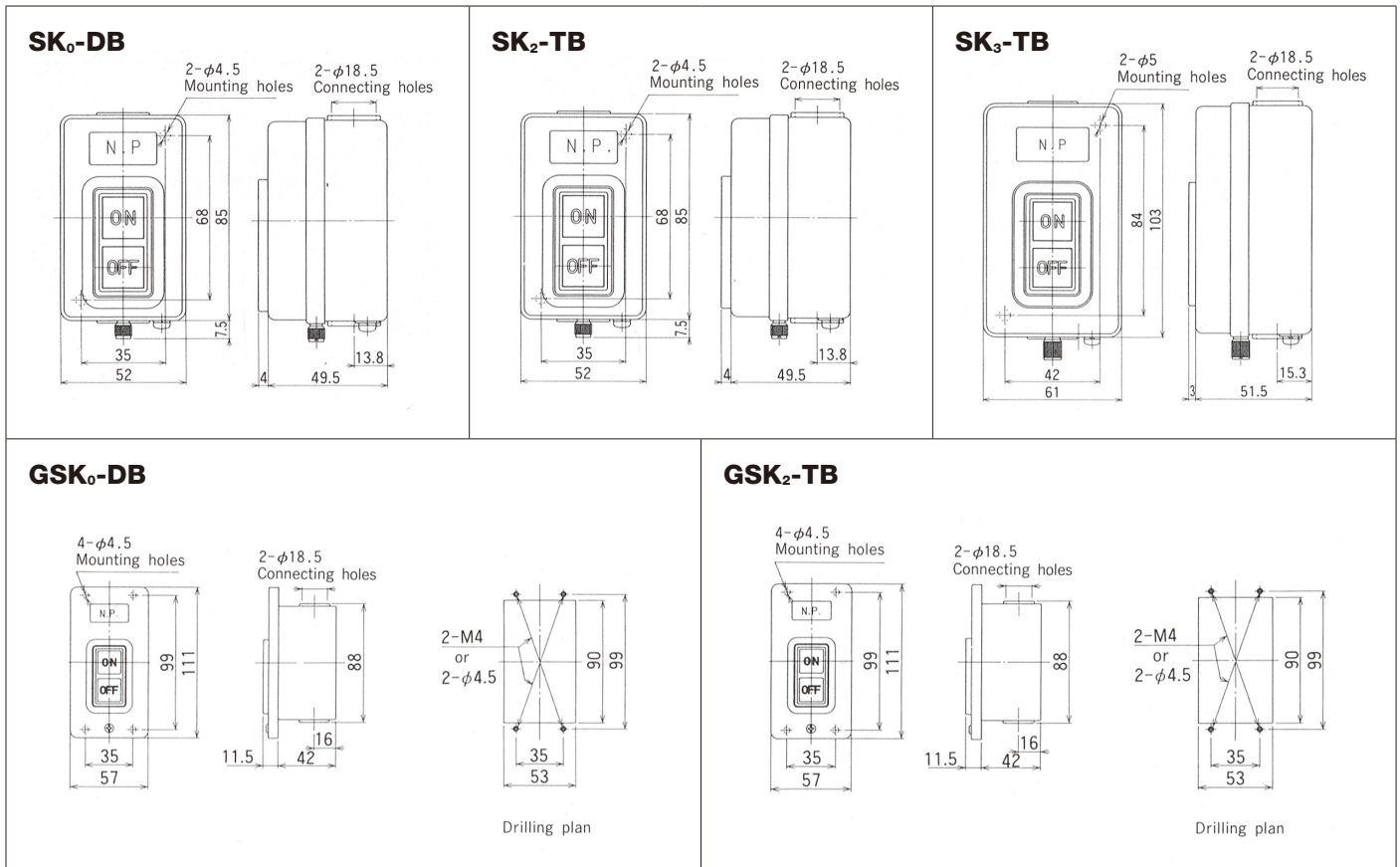







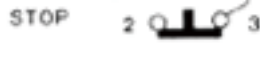
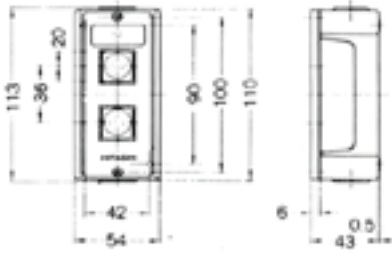

Model	No. of poles	Rated voltage (V)	Applicable motor capacity (HP) (kW)	Resistance load (A)	Mounting method	Masst (kg)
SK <sub>0</sub> -DB	2	500	(1φ) 110V 0.4 (1/2) (1φ) 220V 1.1 (1 1/2)	15	Surface mounting	0.19
GSK <sub>0</sub> -DB					Flush mounting	0.22
SK <sub>2</sub> -TB	3	500	220V 2.2 (3) 440V 2.2 (3)	15	Surface mounting	0.19
GSK <sub>2</sub> -TB					Flush mounting	0.22
SK <sub>3</sub> -TB	3	500	220V 3.7 (5) 440V 3.7(5)	30	surface mounting	0.27

## ■ Dimensions

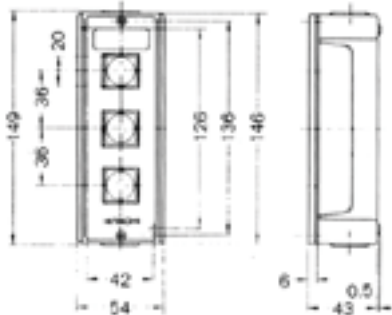

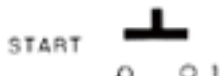
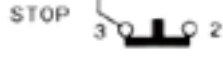
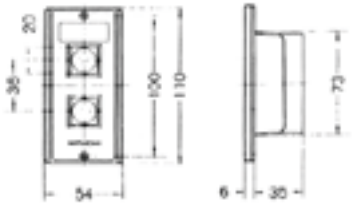
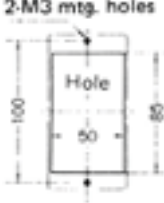
# PUSH BUTTONS (FOR OPERATING OF MAGNETIC CONTACTORS AND SWITCHES)

## ■ Appearance, Dimensions

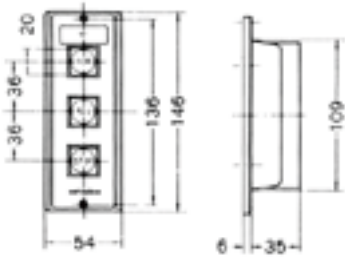
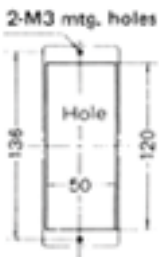
Appearance	Contact arrangement	Dimensions (mm)	Drilling plan
 <p>MB-2B</p>	<p>START</p>  <p>STOP</p> 		<p>2-M4 mtg. holes</p> 
 <p>MB-3B</p>	<p>FOR</p>  <p>REV</p>  <p>STOP</p> 		<p>2-M4 mtg. holes</p> 
 <p>GMB-2B</p>	<p>START</p>  <p>STOP</p> 		<p>2-M3 mtg. holes</p> 
 <p>GMB-3B</p>	<p>FOR</p>  <p>REV</p>  <p>STOP</p> 		<p>2-M3 mtg. holes</p> 

## ■ Contact Ratings

Rated voltage (V)	Rated current (A)
220	3
440	1.5

## ■ Durability

Electrical	Mechanical
220	5

● **Headquarters**

AKS Building, 3, Kanda Neribeicho,  
Chiyoda-ku, Tokyo, 101-0022, Japan  
TEL: <81>(3) 4345-6000  
FAX: <81>(3) 4345-6914

● **Singapore**

**Hitachi Asia Ltd.**

Power & Industrial Systems Group  
24 Jurong Port Road, #03-05 Cwt Distripark,  
Office Block, Singapore, 619097  
TEL: <65>(6305) 7400  
FAX: <65>(6305) 7401

● **Vietnam**

**Hitachi Asia Ltd.(Ho Chi Minh City Office)**

7th Floor, The Landmark, 5B Ton Duc Thang  
Street District 1, Ho Chi Minh City  
TEL: <84>(8) 829-9725  
FAX: <84>(8) 829-9729

**(Ha Noi Office)**

Sun Red River Bldg, 6th Floor,  
23 Phan Chu Trinh Street  
Hoan Kiem District Hanoi  
TEL: <84>(4) 933-3123  
FAX: <84>(4) 933-3125

● **India**

**Hitachi India Trading Pvt. Ltd.**

Hindustan Times House (10th Floor)  
18-20, Kasturba Gandhi Marg., New Delhi, 110001  
TEL: <91>(11) 331-5635, 371-2817, -3953, -3958  
FAX: <91>(11) 331-3742

● **Indonesia**

**Hitachi Asia Ltd. (Jakarta Office)**

Mid Plaza 1, 10th Floor, J.I. Jend.  
Sudirman Kav. 10-11, Jakarta 10220  
TEL: <62>(21) 574-4313  
FAX: <62>(21) 574-4312

● **Malaysia**

**Hitachi Asia (Malaysia) Sdn. Bhd.**

Suite 17.3, Level 17, Menara IMC (Letter Box No.5)  
No. 8 Jalan Sultan Ismail, 50250, Kuala Lumpur  
TEL: <60>(3) 201-8751  
FAX: <60>(3) 201-8757, -8758

● **Philippines**

**Hitachi Asia Ltd. (Philippines Branch)**

25th Floor, Pacific Star Building, Cor. Makati & Sen. Gil.  
Puyat Ave., Makati, Metro Manila  
TEL: <63>(2) 819-7528, -7529  
FAX: <63>(2) 819-7539

● **Thailand**

**Hitachi Asia (Thailand) Co., Ltd.**

18th Floor, Ramaland Building, 952 Rama IV Road  
Bangrak, Bangkok 10500  
TEL: <66>(2) 632-9292  
FAX: <66>(2) 632-9299

● **China**

**Hitachi East Asia Ltd.**

4th Floor, North Tower  
World Finance Centre, Harbour City  
Canton Road, Tsim Sha Tsui, Kowloon  
Hong Kong  
TEL: <852>2735-9218  
FAX: <852>2375-3192

**Hitachi China Ltd. (Beijing Office)**

Room 1412, Beijing Fortune Building  
5 Dong San Huan BeiLu  
Chao Yang District, Beijing 100004  
TEL: <86>(10) 6590-8851, -8852, -8853, -8854  
FAX: <86>(10) 6590-8850

**Hitachi (Shanghai) Trading Co., Ltd.**

18th Floor, Rui Jin Building,  
No.205, Maoming Road(S)  
Shanghai, 200030  
TEL: <86>(21) 6472-1002  
FAX: <86>(21) 6415-8272

**Taiwan Hitachi Asia Pacific Co., Ltd.**

3rd Floor, Hung Kuo Building No.167  
Tun-Hwa North Road, Taipei (105), Taiwan  
TEL: <886>(2) 2718-3666  
FAX: <886>(2) 2718-8180

Information in this brochure is subject to change without notice.

 **Hitachi Industrial Equipment Systems Co., Ltd.**

<http://www.hitachi-ies.co.jp/english/index.htm>

*For further information, please contact your nearest sales representative.*